

Duct hot water heater

The TANNER MD water-supplied air heater should be located directly in a duct to (post) heat intake air. The MD is available in a wide range of capacities ranging from 14,5 to 117 kW.

Features

- Manufactured with a corrosion-resistant aluzinc housing as standard
- Copper/aluminium heat exchanger

The round version is optionally available with rubber sealing.

See Tanner MDA for technical specifications.

Dimensions

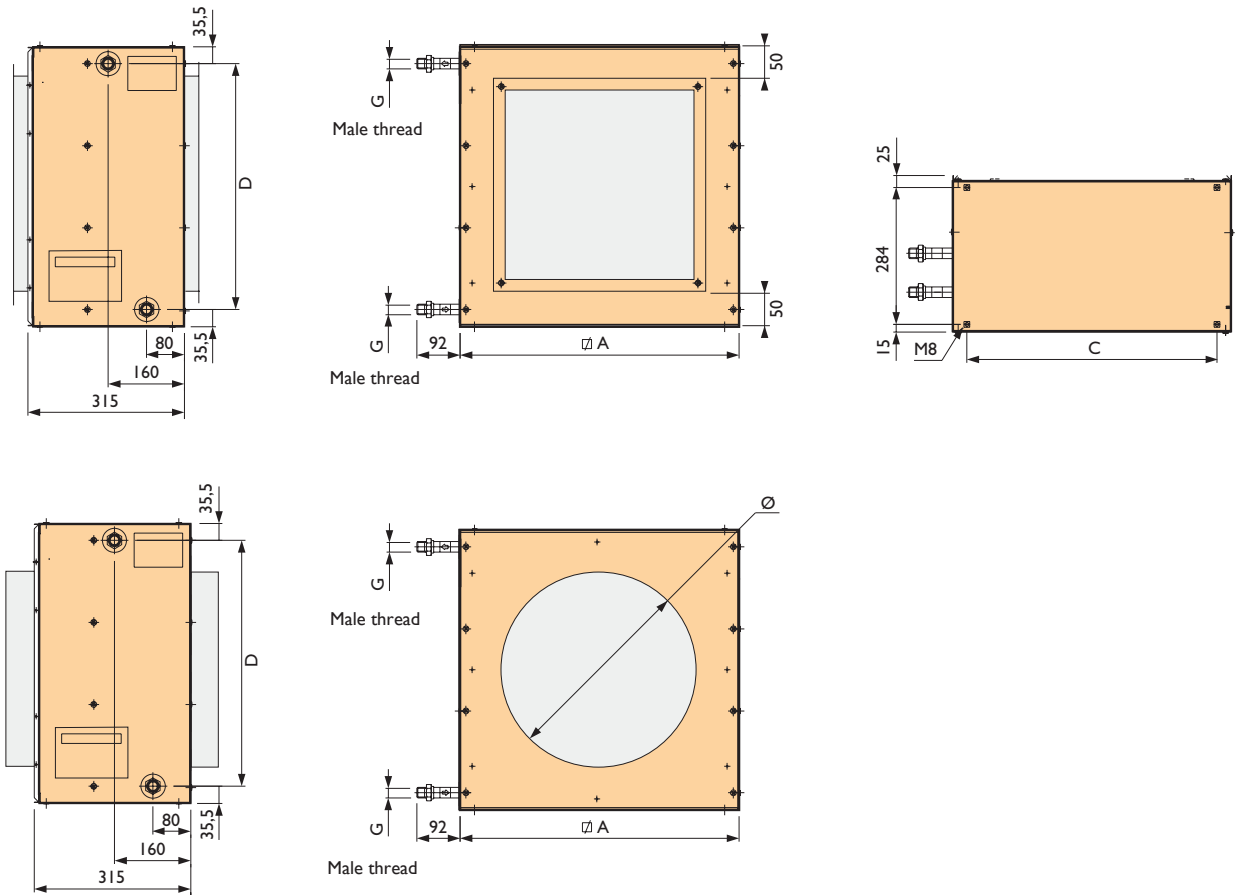

Type	A	C	D	G				Ø
				1R	2R	3R	4R	
100	450	387	379	1"	1"	1"	1"	315/400
200	580	517	509	1"	1"	1"	1"	450/500
300	730	667	659	1"	1"	1 1/4"	1 1/4"	600/630
400	860	797	789	1"	1 1/4"	1 1/2"	1 1/2"	710

Technical information

TYPE DESIGNATION

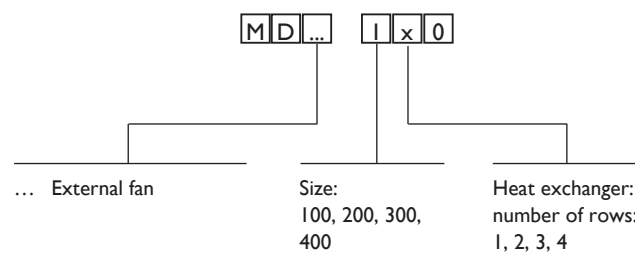

See Tanner MDA tables on pages 46/47 for heat delivery.