

# MARK INFRA ZONE CONTROL

0664015\_R04

Technical manual **EN**

Technisches Handbuch **DE**

Livret technique **FR**

Technisch boek **NL**

Instrukcja techniczna **PL**

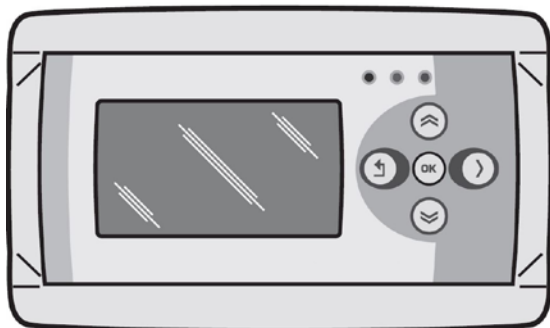



# Read through this document before you begin installation and commissioning

## Warning!

Incorrect installation, adjustment, alteration, repair or maintenance work may lead to material damage or injury. All work must be carried out by certified, qualified professionals. If the appliance is not positioned in accordance with the instructions, the warranty shall be rendered void. This appliance is not intended for use by children or persons with a physical, sensory or mental handicap, or who lack the required experience or expertise, unless they are supervised or have been instructed in the use of the appliance by somebody who is responsible for their safety. Children must be supervised to ensure that they do not play with the appliance.

EN

## 1.0 General

### 1.1 Subject to modification

The manufacturer is continuously striving to improve its products and reserves the right to make changes in the specifications without prior notice. The technical details are assumed to be correct, but do not form the basis for a contract or guarantee. All orders are accepted on the standard terms of our general conditions of sale and delivery (available on request). The information in this document is subject to change without notice. The most recent version of this manual is always available at [www.markclimate.com/downloads](http://www.markclimate.com/downloads).

### 1.2 General warnings

Installation must meet the current local and/or national regulations. The Infra zone control must therefore be installed by a competent and qualified fitter, in compliance with the national and international legislation. In the event of faulty installation, calibration, modification, maintenance or repair, the guarantee shall cease to apply.

## 2.0 Technical specifications

### 2.1 Technical details Infra zone control

- Delivery: Control panel with external display
- Dimensions external display (wxhxd): 160x98x43mm
- Dimensions switchbox (wxhxd): 376 x 300 x 120mm
- Weight switchbox: 4800 gram
- Weight display: 206 gram
- Protection class: IP20
- Mounting of display: built-in / wall installation
- Mounting of switchbox: built-on / wall mounting
- Number of zones: 3
- Number of Infra's per zone: 6
- Temperature range: 2...40°C per 0,5°C.
- Operating options: Auto, continuous day, continuous night or continuous off
- Day-/night temperature monitoring with reading of the actual room temperature on the display

- Automatic switching between summer/winter time.
- Control: on/off, high/low or modulating
- High/low control: Auto 1, 2 or 3K
- Time switch with week program (7 switch blocks)
- Overtime timer: 0-180 min. per zone
- Signaling of burner malfunction
- Reset option to release a burner malfunction per zone
- PIN security to modify for example switching times and temperatures
- Languages: English, French, German and Dutch
- Calibration temperature sensor: range from -3°C to +3°C per 0,5°C
- Power: 230Vac / 50Hz.
- Modbus TCP/IP
- Embedded webserver

### 2.2 Technical details for external globe sensor

- Type name : RSTF PT1000
- Article code : 06 29 082
- Resistance : PT1000
- Dimensions (wxhxd) : 85 x 85 x 27mm (40 mm incl. height external globe sensor)
- Weight : 42 gram
- Electrical connection : 0.14-1.5mm<sup>2</sup>
- Degree of protection : IP30

### 2.3 External globe sensor resistance table

PT1000					
°C	Ω	°C	Ω	°C	Ω
- 50	803	+ 20	1078	+ 90	1347
- 40	843	+ 30	1117	+ 100	1385
- 30	882	+ 40	1155	+ 110	1423
- 20	922	+ 50	1194	+ 120	1461
- 10	961	+ 60	1232	+ 130	1498
0	1000	+ 70	1271	+ 140	1536
+ 10	1039	+ 80	1309	+ 150	1573

### 2.4 Factory settings Zone Control Infra



- Menu code : 1000
- Switching times : Block 1 MO,TU,WE,TH, FR 08:00-17:00 hrs  
Block 2-7 off
- Room temperature : Day-time temperature 18°C  
Night-time temperature 08°C
- Calibration : +0.0

## 3.0 Installation

### 3.1 General

The Infra zone control exists of:

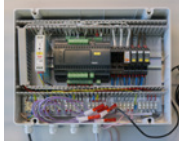
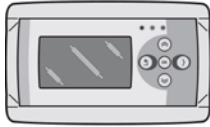
- A control box with in it connection terminals and controller;
- An external display to operate the controller;
- External globe sensor(s)

			
Control box	Display	Wall mounting plate	External globe sensor
3003795			0629082

After unpacking, check the Infra zone control and (if ordered) external globe sensor for damage. Check for correctness of the type/model and voltage.

### 3.2 Mounting Infra zone control

Determine an appropriate place to mount the Infra zone control (control box, external display and external globe sensor).

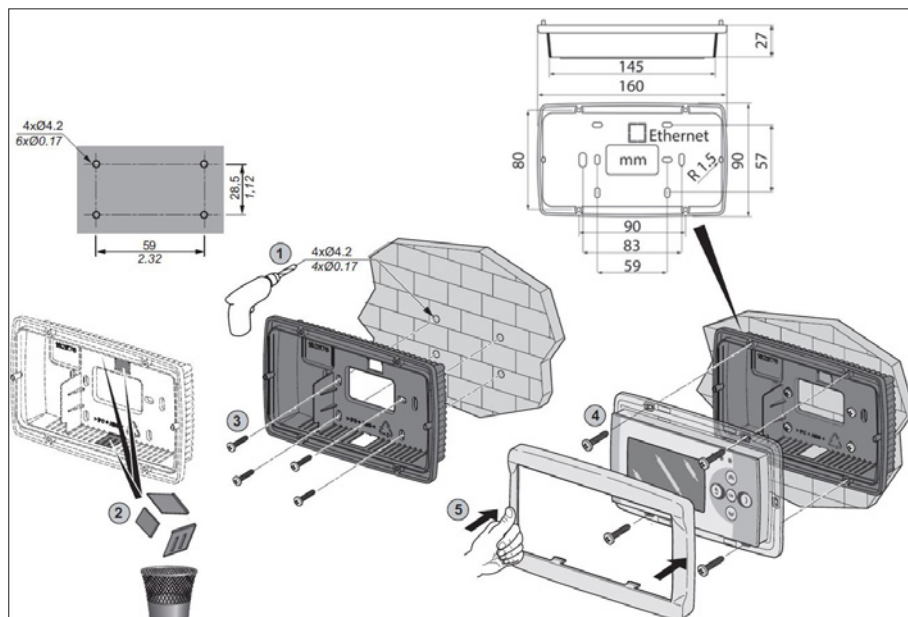

Place the external globe sensor in a draft-free area, within sight of the unit at a height of approx. 1,5 meter from the floor. Connect the sensor to the appropriate terminals in the Infra zone control. See table on the next page for the correct cable diameter.

Make sure the power is off before connecting the wiring. If this is not the case, the power must be turned off before proceeding. When switching off the power of the device the technical book/ operation manual should be taken into account.

Connect the Infra zone control according to the electrical diagram at the end of this chapter.

Diameter	Length
0.8mm <sup>2</sup>	80 meter
1.0mm <sup>2</sup>	100 meter
1.5mm <sup>2</sup>	150 meter

 It is recommended that a protected cable is used here.

### 3.3 Check connection controller and display

When the display and controller are connected properly through CAN-bus connections, the lowest green LED will blink.

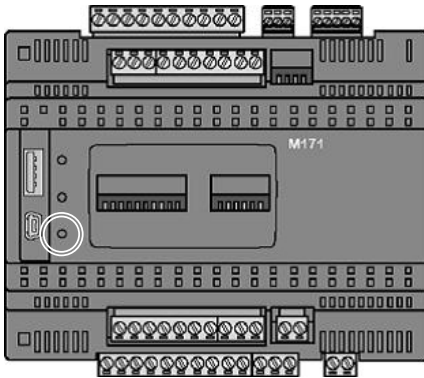





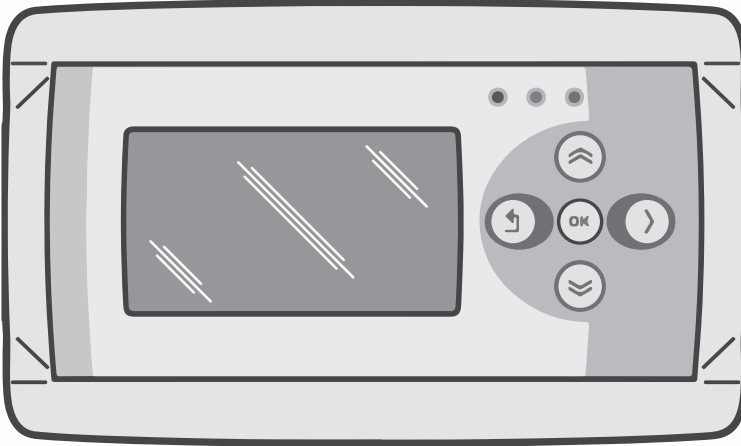

## 4.0 Operation and display

### 4.1 Operation



EN

Buttons	
	<ul style="list-style-type: none"> <li>• Scroll up</li> <li>• Return to last page</li> <li>• Increase value / edit setting</li> <li>• Go to next</li> </ul>
	<ul style="list-style-type: none"> <li>• Scroll down</li> <li>• Go to next page</li> <li>• Decrease value / edit setting</li> <li>• Go to last</li> </ul>
	<ul style="list-style-type: none"> <li>• Scroll down</li> <li>• Go to next level/menu/edit mode (open folder, subfolder, parameter setting)</li> <li>• Open and confirm setting/parameter setting</li> <li>• Confirm the change/setting.</li> </ul>
	<ul style="list-style-type: none"> <li>• Move cursor to the right in edit mode</li> </ul>
	<ul style="list-style-type: none"> <li>• Exit menu page / go back to last menu</li> <li>• Move cursor to the left in edit mode</li> <li>• (Press and hold) Leave editing mode without making changes</li> </ul>

LED	LED green / orange / red
	In case the red LED is lighting, it means an Infra heater is in fault condition. Through the display it can be seen in which zone this is.

## 4.2 Menu structure

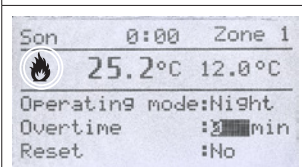
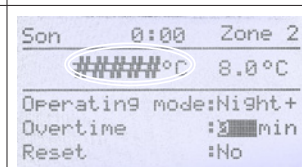
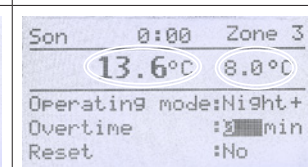
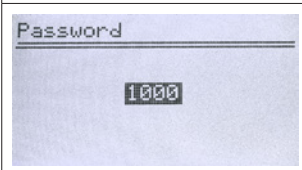
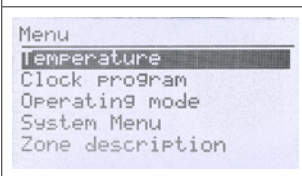
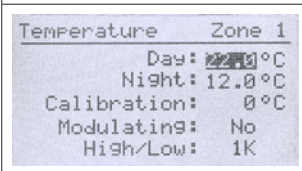
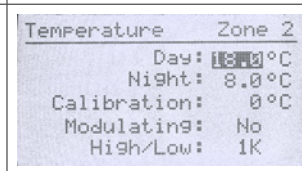
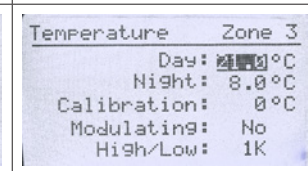
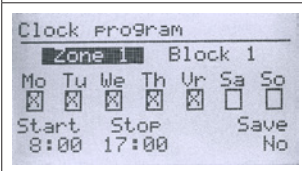
		
 <p>On: flame Off: no flame</p>	 <p>#####: No sensor connected.</p>	 <p>13.6 °C: Measured temperature. 8.0 °C: Setpoint.</p>
		
		
		
<p>Set the desired day temperature, night temperature, calibration, modulating control, high/low control for each zone separately.</p>		
		
<p><b>Clock program</b> Set the clock program for each zone. It is possible to control 3 zones and have 7 timing functions per day. Select the days, start and end times.</p>		



```

Operating mode
Zone 1      auto
Zone 2      night
Zone 3      night

```

### Operating mode

Set-up for operating mode for each zone

- auto (clock program will be followed),
- continuous day,
- continuous night,
- out

```

System Menu
Date/Time
Language
IP address
Change Password
Software Version

```

### System menu

In this menu the date/time, language, IP address and password can be changed.

The software version can be requested.

```

Zone description
Zone 1: Zone 1
Zone 2: Zone 2
Zone 3: Zone 3

```

### Zone description

To name each zone differently instead of standard: zone 1, zone 2, zone 3.

## 4.3 System menu

```

System Menu
Date/Time
Language
IP address
Change Password
Software Version

```

### System menu

In this menu the date/time, language, IP address and password can be changed.

The software version can be requested.



```

Date/Time
--/--/--  0:00:00
09/09/15  0:00:00
Tue                Save
                        No

```

### Date/time

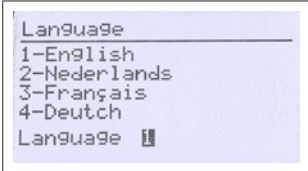
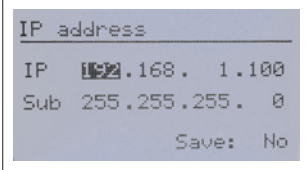
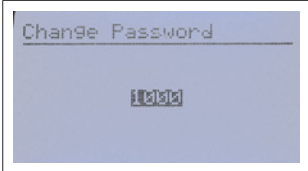
Set-up of actual date and time.

		
<p><b>Language</b> Set-up for desired language (English, Nederlands, Français, Deutsch).</p>		
		
<p><b>IP address</b> Set-up IP-address and Subnetmask <i>Note: After saving the IP address the controller will restart.</i></p>		
		
<p><b>Change password</b> Set-up for changing the password to get access to the menu or to the webpage (standard password is: 1000).</p>		
		
<p><b>Software version</b> The actual software version.</p>		

#### 4.4 Operation with a computer

The unit can be operated using a PC or laptop.

Connect your PC or laptop by means of an Ethernet jack on the display.

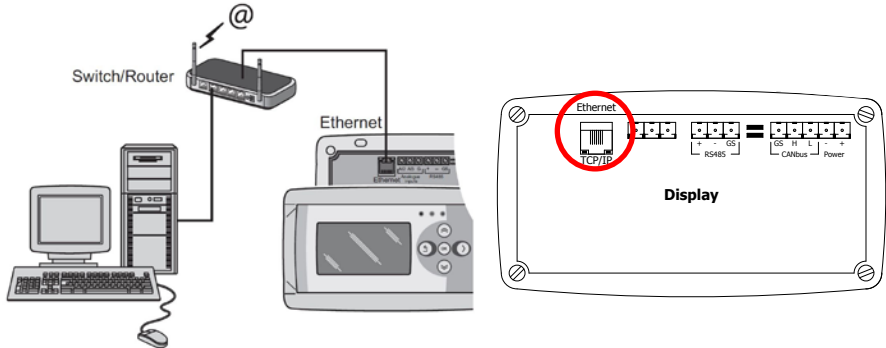

EN

Once you have connected both, start your internet browser\* and enter the IP address (Default address: 192.168.1.100).

When you have a connection a log in screen will appear.  
Enter the username and password.

User name: user  
Password: 1000 (factory setting)\*\*

When the log in details have been correctly entered a tab with status/settings will appear in your browser. Through the tabs at the top of the page the desired language can be chosen or a menu can be opened to view or change the clock programm on screen.

\* The factory advises Google Chrome or Mozilla Firefox.

\*\* In case you have edited this through the display of the Infra zone control (menu/system menu/change password) you must enter the changed password.

English

Nederlands

Français

Deutsch

## Status

	0	/	0	/	15	0	:	0	:	0
--	---	---	---	---	----	---	---	---	---	---

Zone	Temperature	Setpoint	Operating mode	Unit	High	Error
Zone 1	22.7 °C	8.0 °C	Night	<input type="checkbox"/>	<input type="checkbox"/>	<input type="checkbox"/>
Zone 2	---- °C	8.0 °C	Off	<input type="checkbox"/>	<input type="checkbox"/>	<input type="checkbox"/>
Zone 3	---- °C	8.0 °C	Off	<input type="checkbox"/>	<input type="checkbox"/>	<input type="checkbox"/>

## Settings

Zone	Setpoint Day	Setpoint Night	Operating mode	Overtime
Zone 1	17.5 °C	8.0 °C	Clock(Auto)	0 min.
Zone 2	18.0 °C	8.0 °C	Off	0 min.
Zone 3	18.0 °C	8.0 °C	Off	0 min.

4.4.2 Menu clock program

English

Nederlands

François

Deutsch

Zone 1

Mon	Tue	Wen	Thu	Vri	Sat	Sun	Start	Stop
<input type="checkbox"/>	<input checked="" type="checkbox"/>	<input checked="" type="checkbox"/>	<input checked="" type="checkbox"/>	<input checked="" type="checkbox"/>	<input type="checkbox"/>	<input type="checkbox"/>	8 : 0	- 17 : 0
<input type="checkbox"/>	<input type="checkbox"/>	<input type="checkbox"/>	<input type="checkbox"/>	<input type="checkbox"/>	<input type="checkbox"/>	<input type="checkbox"/>	0 : 0	- 0 : 0
<input type="checkbox"/>	<input type="checkbox"/>	<input type="checkbox"/>	<input type="checkbox"/>	<input type="checkbox"/>	<input type="checkbox"/>	<input type="checkbox"/>	0 : 0	- 0 : 0
<input type="checkbox"/>	<input type="checkbox"/>	<input type="checkbox"/>	<input type="checkbox"/>	<input type="checkbox"/>	<input type="checkbox"/>	<input type="checkbox"/>	0 : 0	- 0 : 0
<input type="checkbox"/>	<input type="checkbox"/>	<input type="checkbox"/>	<input type="checkbox"/>	<input type="checkbox"/>	<input type="checkbox"/>	<input type="checkbox"/>	0 : 0	- 0 : 0
<input type="checkbox"/>	<input type="checkbox"/>	<input type="checkbox"/>	<input type="checkbox"/>	<input type="checkbox"/>	<input type="checkbox"/>	<input type="checkbox"/>	0 : 0	- 0 : 0
<input type="checkbox"/>	<input type="checkbox"/>	<input type="checkbox"/>	<input type="checkbox"/>	<input type="checkbox"/>	<input type="checkbox"/>	<input type="checkbox"/>	0 : 0	- 0 : 0

EN



Zone 2

Mon	Tue	Wen	Thu	Vri	Sat	Sun	Start	Stop
<input checked="" type="checkbox"/>	<input checked="" type="checkbox"/>	<input checked="" type="checkbox"/>	<input checked="" type="checkbox"/>	<input checked="" type="checkbox"/>	<input type="checkbox"/>	<input type="checkbox"/>	8 : 0	- 17 : 0
<input type="checkbox"/>	<input type="checkbox"/>	<input type="checkbox"/>	<input type="checkbox"/>	<input type="checkbox"/>	<input type="checkbox"/>	<input type="checkbox"/>	0 : 0	- 0 : 0
<input type="checkbox"/>	<input type="checkbox"/>	<input type="checkbox"/>	<input type="checkbox"/>	<input type="checkbox"/>	<input type="checkbox"/>	<input type="checkbox"/>	0 : 0	- 0 : 0
<input type="checkbox"/>	<input type="checkbox"/>	<input type="checkbox"/>	<input type="checkbox"/>	<input type="checkbox"/>	<input type="checkbox"/>	<input type="checkbox"/>	0 : 0	- 0 : 0
<input type="checkbox"/>	<input type="checkbox"/>	<input type="checkbox"/>	<input type="checkbox"/>	<input type="checkbox"/>	<input type="checkbox"/>	<input type="checkbox"/>	0 : 0	- 0 : 0
<input type="checkbox"/>	<input type="checkbox"/>	<input type="checkbox"/>	<input type="checkbox"/>	<input type="checkbox"/>	<input type="checkbox"/>	<input type="checkbox"/>	0 : 0	- 0 : 0
<input type="checkbox"/>	<input type="checkbox"/>	<input type="checkbox"/>	<input type="checkbox"/>	<input type="checkbox"/>	<input type="checkbox"/>	<input type="checkbox"/>	0 : 0	- 0 : 0

Zone 3

Mon	Tue	Wen	Thu	Vri	Sat	Sun	Start	Stop
<input type="checkbox"/>	<input checked="" type="checkbox"/>	<input checked="" type="checkbox"/>	<input checked="" type="checkbox"/>	<input checked="" type="checkbox"/>	<input type="checkbox"/>	<input type="checkbox"/>	8 : 0	- 17 : 0
<input type="checkbox"/>	<input type="checkbox"/>	<input type="checkbox"/>	<input type="checkbox"/>	<input type="checkbox"/>	<input type="checkbox"/>	<input type="checkbox"/>	0 : 0	- 0 : 0

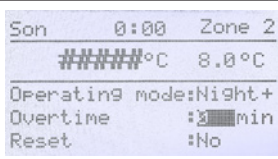
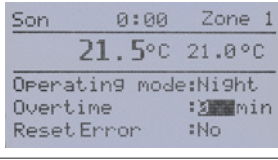
## 5.0 Malfunctions

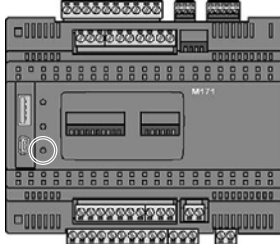
Image	Alert	Where	Meaning
	#####°C	Display	No sensor connected.
	Reset error: No	Display	An Infra has a fault. Through the display it can be seen in which zone.
	The right LED burns red	Display	An Infra has a fault. Through the display it can be seen in which zone.
	----- °C	Internet browser	No sensor connected.
	Lowest LED <u>doesn't</u> flash green.	CANbus	The display and the controller aren't connected with each other.

## 6.0 Discarding

Whenever the Infra zone control is replaced or removed, it should be recycled or scrapped in accordance with national regulations and/or local by-laws.

## 7.0 Attachments

- [1] Wiring diagram display
- [2] Modbus-list

# 8.0 Electrical diagram

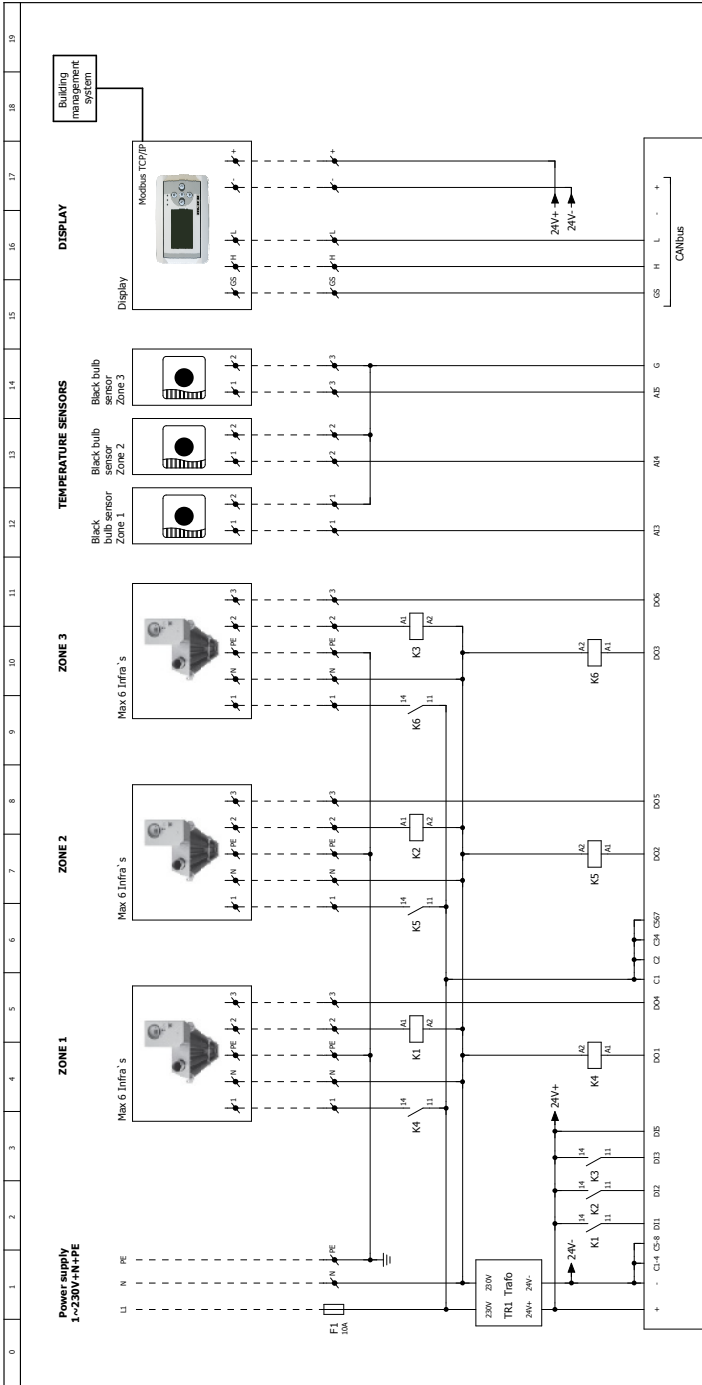

<p><b>Connect maximum of 6 Infra to 1 zone.</b></p> <p>Infra1 Infra2 Infra... Infra6</p> <p>1 - Phase 230V N - Zero PE - Earth 2 - Failure 3 - High</p>	<p><b>Cabling temperature sensors</b></p> <p>Length:</p> <p>Diameter:</p> <p>0,8 mm<sup>2</sup> = max 80 metres 1,0 mm<sup>2</sup> = max 100 metres 1,5 mm<sup>2</sup> = max 150 metres 2,5 mm<sup>2</sup> = max 250 metres</p> <p><b>⚠ Attention</b> Use a shielded cable for this purpose!</p>	<p><b>Assembly of external globe sensor:</b></p> <p>Temperature sensor draught-free within view of the appliance Distance of 1.5 meter from the floor If possible place 4 to 5 metres from Infra.</p>	<p><b>Relays:</b></p> <p>K1 - Failure zone 1 K2 - Failure zone 2 K3 - Failure zone 3 K4 - Heat demand zone 1 K5 - Heat demand zone 2 K6 - Heat demand zone 3</p>	<p>Zone control Infra</p>	<p>Electrical drawing Doc. TRD Date 1.12.2016 User Norm Version 1.1</p>
<p>Drawing Group: 1-AB1500-EN Type: 30.03.2016</p>					<p>10</p>







# Lesen Sie dieses Dokument sorgfältig durch, bevor Sie das Gerät installieren

## Warnhinweis!

Fehlerhaft durchgeführte Installationen, Einstellungen, Änderungen, Reparaturen oder Wartungsmaßnahmen können zu Sachschäden und Verletzungen führen. Alle Arbeiten müssen von geprüften, qualifizierten Fachleuten durchgeführt werden. Falls das Gerät nicht vorschriftsgemäß aufgestellt wird, erlischt die Garantie.

Dieses Gerät ist nicht für den Gebrauch durch Personen (einschließlich Kindern) mit verminderter körperlicher, Sinnes- oder geistiger Leistungsfähigkeit oder mangelnder Erfahrung und mangelnden Kenntnissen bestimmt, sofern sie nicht unter Aufsicht stehen oder durch eine Person, die für ihre Sicherheit verantwortlich ist, im Gebrauch des Geräts angeleitet werden. Kinder müssen vom Gerät ferngehalten werden.

DE

## 1.0 Allgemeines

### 1.1 Änderungen vorbehalten

Der Hersteller strebt eine kontinuierliche Verbesserung der Produkte an und behält sich das Recht vor, ohne vorherige Mitteilung Änderungen an den technischen Daten vorzunehmen. Die technischen Angaben werden als korrekt angenommen, bilden aber keine Grundlage für einen Vertrag oder Gewährleistungsansprüche. Sämtliche Bestellungen werden unter den Standardbedingungen unserer allgemeinen Verkaufs- und Lieferbedingungen (auf Anfrage erhältlich) entgegengenommen. Die Informationen in diesem Dokument können sich ohne vorherige Ankündigung ändern. Die neueste Version dieses Handbuches finden Sie immer auf unserer Internetseite unter [www.mark.de/downloads](http://www.mark.de/downloads).

### 1.2 Allgemeine Warnhinweise

Die Installation muss den geltenden landesweiten und örtlichen Bestimmungen entsprechen. Lassen Sie die INFRA Zonen Regelung daher nur von fachkundigen und qualifizierten Installateuren unter Berücksichtigung der nationalen und internationalen Vorschriften installieren. Im Falle einer unsachgemäßen Installation, Feinabstimmung, Änderung, Wartung oder Instandsetzung erlischt die Gewährleistung.

## 2.0 Technische Daten

### 2.1 Technische Daten INFRA Zonen Regelung

- Lieferung: Schaltkasten mit externem Display
- Abmessung ext. Display (BxHxT): 160 x 98 x 43 mm
- Abmessung Schaltschrank (BxHxT): 376 x 300 x 120 mm
- Gewicht Schaltschrank: 4800 g
- Gewicht Display: 206 g
- Schutzklasse: IP20
- Montage Display: Einbau / Wandmontage
- Montage Schaltschrank: Aufbau / Wandmontage
- Zonenanzahl: 3

- maximale Anzahl INFRA-Dunkelstrahler pro Zone: 6
- Bereich der Temperatureinstellung: 2 bis 40°C in 0,5°C Schritten
- Betriebsmodus: automatisch, kontinuierlich bei Tag, kontinuierlich bei Nacht oder kontinuierlich aus
- Tag-/Nachttemperatur Überwachung mit Anzeige und ablesen der aktuellen Raumtemperatur auf dem Display
- automatische Anpassung der Sommer-/Winterzeit
- Regelung: Ein/Aus, Hoch/Tief, modulierend (PWM)
- Hoch/Tief Regelung: automatisch 1, 2 oder 3K
- Schaltuhr mit Wochenprogramm (7 Schaltblöcke)
- Überstundentimer: 0-180 Minuten pro Zone
- Signalisierung einer Brennerstörung pro Zone
- Resetmöglichkeit zur Entriegelung einer Brennerstörung pro Zone
- Sicherheitscode um u.a. die Schaltzeiten und Temperaturen zu verändern
- Sprachen: Englisch, Französisch, Deutsch, Niederländisch
- Justierung Temperaturfühler: regulierbar von -3°C bis +3°C in 0.5°C Schritten
- Stromversorgung: 230 Vac/ 50Hz
- Modbus TCP/IP
- eingebauter Webserver

## 2.2 Technische Daten externer Schwarzkugelfühler

- Typenbezeichnung : RSTF PT 1000
- Artikelnummer : 06 29 082
- Widerstand : PT1000
- Abmessung (BxHxT) : 85 x 85 x 27mm (40 mm inkl. Höhe des Schwarzkugelfühlers)
- Gewicht : 42 g
- Stromanschluss : 0.14-1.5mm<sup>2</sup>
- Schutzklasse : IP30

## 2.3 Widerstandstabelle (externer) Schwarzkugelfühler

PT 1000					
°C	Ω	°C	Ω	°C	Ω
- 50	803	+ 20	1078	+ 90	1347
- 40	843	+ 30	1117	+ 100	1385
- 30	882	+ 40	1155	+ 110	1423
- 20	922	+ 50	1194	+ 120	1461
- 10	961	+ 60	1232	+ 130	1498
0	1000	+ 70	1271	+ 140	1536
+ 10	1039	+ 80	1309	+ 150	1573

## 2.4 Werkseinstellungen INFRA Zonen Regelung



- Menücode : 1000
- Schaltzeiten : Block 1 MO, DI, MI, DO, FR 08:00 bis 17:00 Uhr  
Block 2 bis 7 aus
- Raumtemperatur : Tagestemperatur 18°C  
Nachttemperatur 08°C
- Justierung : +0.0

## 3.0 Installation

### 3.1 Allgemein

Die INFRA Zonen Regelung besteht aus:

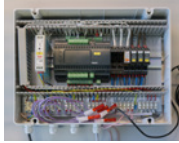
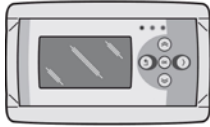
- einen Schaltschrank mit Anschlussklemmen und Regler;
- ein externes Display zur Bedienung der Regelung;
- externer Schwarzkugelfühler

			
Schaltschrank	Display	Wandmontageplatte	Schwarzkugelfühler
3003795			0629082

Kontrollieren Sie nach dem Auspacken die INFRA Zonen Regelung und den mitgelieferten Schwarzkugelfühler auf Beschädigungen. Prüfen Sie den Typen/das Model und die elektrische Spannung.

### 3.2 Montage INFRA Zonen Regelung

Bestimmen Sie einen geeigneten Platz um die INFRA Zonen Regelung (Schaltschrank, externes Display und Schwarzkugelfühler) zu montieren.

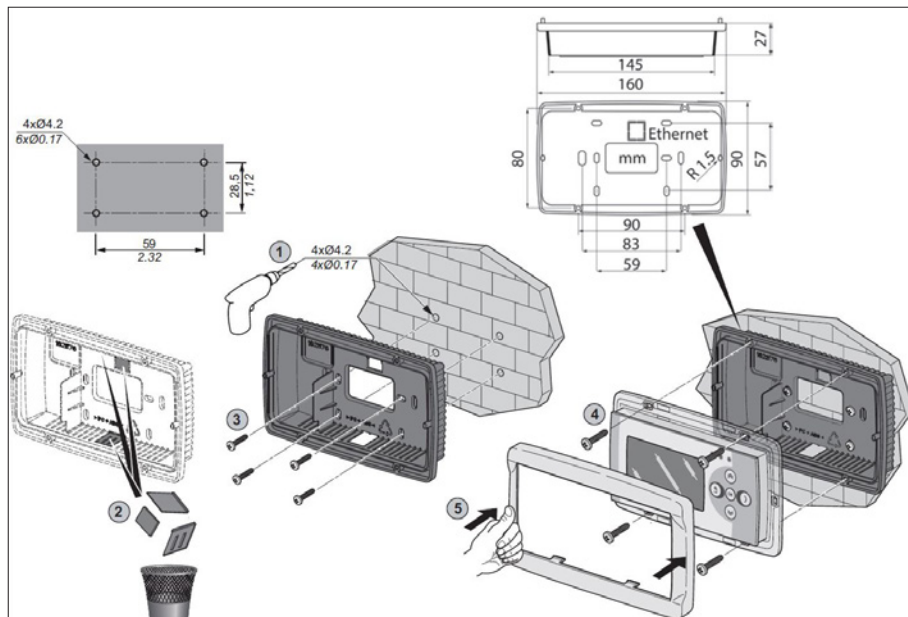

Bringen Sie den Schwarzkugelfühler zugfrei, in Sichtweite des Gerätes auf einer Höhe von ca. 1,5 m ab Fußboden, an. Schließen Sie außerdem den Fühler an die dafür vorgesehenen Klemmen in der INFRA Zonen Regelung an. Die folgende Tabelle zeigt die richtigen Kabelquerschnitte.

Bevor Sie die Verkabelung vornehmen, prüfen Sie bitte ob der Strom abgestellt ist. Falls dies nicht der Fall sein sollte, muss zuerst der Strom abgestellt werden, bevor Sie weitermachen können. Bei dem Ausstellen des Stroms und das Anschließen des Gerätes muss das Technische Handbuch/ Bedienungsanleitung des Gerätes befolgt werden.

Schließen Sie die INFRA Zonen Regelung entsprechend der elektrischen Schaltpläne an, welche hinten im Technischen Handbuch zu finden sind.

Durchmesser	Länge
0.8mm <sup>2</sup>	80 Meter
1.0mm <sup>2</sup>	100 Meter
1.5mm <sup>2</sup>	150 Meter

 Es wird angeraten hierfür ein separates Kabel zu verwenden.

### 3.3 Überprüfung Verbindung zwischen Regler und Display

Wenn der Regler und das Display über den CAN-bus Anschluss richtig miteinander verbunden sind, blinkt das unterste Lämpchen grün auf.

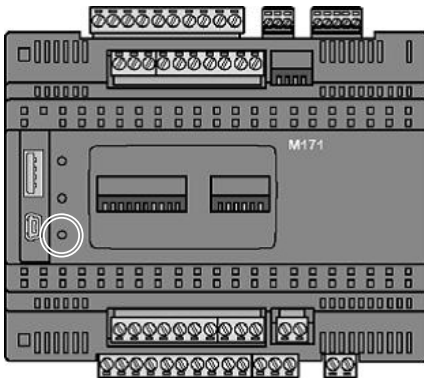





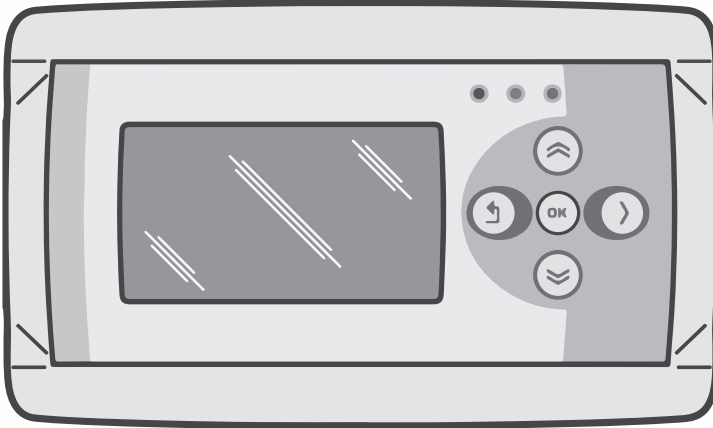

## 4.0 Bedienung und Display

### 4.1 Bedienung



DE

Knöpfe	
	<ul style="list-style-type: none"> <li>• hoch scrollen</li> <li>• kehren Sie zurück zur vorherigen Seite</li> <li>• Wert erhöhen / Einstellung verändern</li> <li>• gehen Sie weiter</li> </ul>
	<ul style="list-style-type: none"> <li>• runter scrollen</li> <li>• gehen Sie weiter zur nächsten Seite</li> <li>• Wert verringern / Einstellungen ändern</li> <li>• gehen Sie zurück</li> </ul>
	<ul style="list-style-type: none"> <li>• runter scrollen</li> <li>• gehen Sie zum nächsten Level/Menü/Eingabemodus (öffnen Sie den Ordner, Unterordner, Parametereinstellung)</li> <li>• Öffnen und Bestätigen der Einstellungen/Parametereinstellungen</li> <li>• Bestätigen der Änderung/Einstellung</li> </ul>
	<ul style="list-style-type: none"> <li>• Bewegen Sie den Cursor nach rechts in den Eingabemodus</li> </ul>
	<ul style="list-style-type: none"> <li>• verlassen Sie die Menüseite / gehen Sie zurück zum vorherigen Menü</li> <li>• Bewegen Sie den Cursor nach links in den Eingabemodus</li> <li>• (drücken und festhalten) Verlassen Sie den Eingabemodus ohne jegliche Änderungen vorzunehmen</li> </ul>

Lampen	Lämpchen grün / orange / rot
	Sobald das rote Lämpchen aufleuchtet, bedeutet dies, dass der IN-FRA Dunkelstrahler auf Störung steht. Über das Display kann man nachverfolgen in welcher Zone sich die Störung befindet.

## 4.2 Menüstruktur

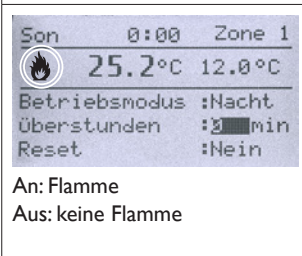
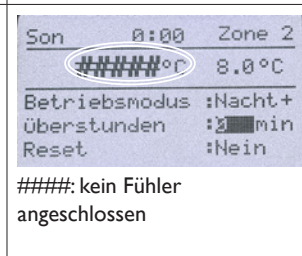
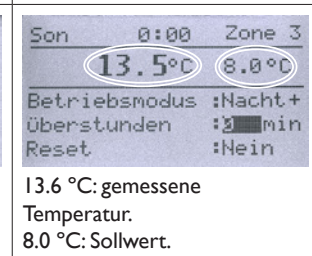
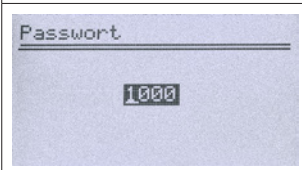
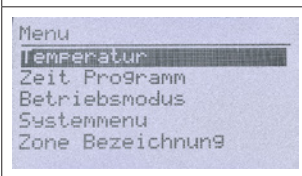
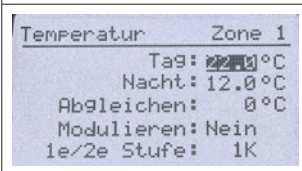
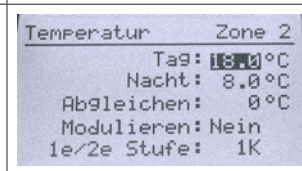
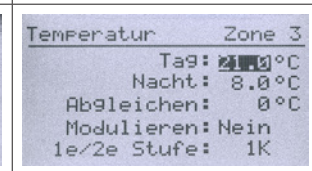
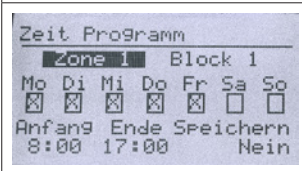
		
 <p>An: Flamme Aus: keine Flamme</p>	 <p>####: kein Fühler angeschlossen</p>	 <p>13.6 °C: gemessene Temperatur. 8.0 °C: Sollwert.</p>
		
		
		
<p>Einstellen der gewünschten Tagestemperatur, Nachttemperatur, Kalibrierung, modulierenden Regelung, hoch/tief Regelung für jede Zone separat.</p>		
		
<p><b>Zeitprogramm</b> Einstellen des Zeitprogramms pro Zone. Von wann bis wann muss der Regler in die Tagestemperatur schalten. Pro Zone hat man die Möglichkeit 7 verschiedene Programmblöcke zu programmieren. Pro Block muss der Arbeitstag, Beginn und Ende ausgewählt werden.</p>		

<pre> Betriebsmodus Zone 1      Auto Zone 2      Nacht Zone 3      Nacht </pre>		
---	--	--

### Betriebsmodus

Pro Zone kann eingestellt werden, welcher Betriebsmodus befolgt werden muss

- auto (Zeitprogramm wird befolgt)
- kontinuierlich bei Tag
- kontinuierlich bei Nacht
- aus

<pre> Systemmenu Datum/Zeit Sprache IP Adresse Passwort ändern Software Version </pre>		
--	--	--

### System Menü

In diesem Menü kann Datum/Zeit, Sprache, IP Adresse, und das Passwort geändert werden. Zudem kann die Softwareversion abgefragt werden.

<pre> Zone Bezeichnung Zone 1: Zone 99 Zone 2: Zone 2 Zone 3: Zone 3 </pre>		
---	--	--

### Zonen Benennung

Jede Zone kann namentlich benannt werden. Standardmäßig sind die Zonen in Zone 1, Zone 2, Zone 3 benannt.

## 4.3 Das System Menü

<pre> Systemmenu Datum/Zeit Sprache IP Adresse Passwort ändern Software Version </pre>		
--	--	--

### System Menü

In dem Menü kann Datum/Zeit, Sprache, IP Adresse, und das Passwort geändert werden. Zudem kann die Softwareversion abgefragt werden.

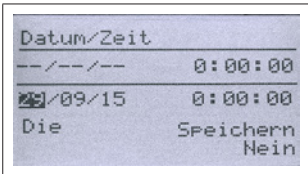
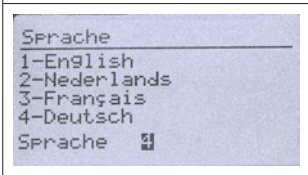
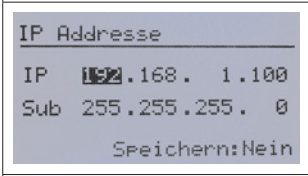
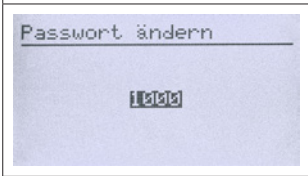
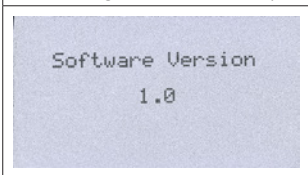
		
<p><b>Datum/Zeit</b> Einstellen des aktuellen Datums und der aktuellen Zeit.</p>		
		
<p><b>Sprache</b> Gewünschte Sprache auswählen (English, Nederlands, Français, Deutsch).</p>		
		
<p><b>IP Adresse</b> Einstellen der IP Adresse und Subnetzmaske <i>Anmerkung: Nach dem Speichern der IP Adresse startet der Regler neu.</i></p>		
		
<p><b>Passwort ändern</b> Um in das Menü zu gelangen oder sich über die Webseite einzuloggen, kann das zuvor eingestellte Passwort geändert werden (Passwort ist standardmäßig auf 1000 eingestellt).</p>		
		
<p><b>Softwareversion</b> Die aktuelle Softwareversion.</p>		



#### 4.4 Bedienung mit dem Computer

Das Gerät kann mit dem PC oder Laptop bedient werden.

Verbinden Sie den PC oder Laptop mithilfe eines LAN-Kabels (Ethernet) mit dem Display.

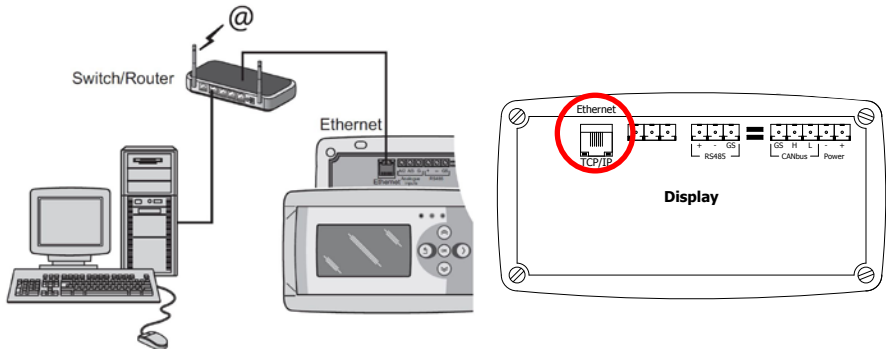

DE

Nachdem die Verbindung steht, starten Sie Ihren Internetbrowser\* und geben Sie die IP Adresse ein (standardmäßig eingestellte Adresse: 192.168.1.100).

Sobald Sie verbunden sind, erscheint ein Fenster zum Einloggen. Geben Sie den Benutzernamen und das Passwort ein.

Benutzername: user  
Passwort: 1000 (standardmäßig ab Werk)\*\*

Sobald die Login-Daten richtig eingegeben wurden, erscheint eine Registerkarte in Ihrem Browser. Über die Registerkarten oberhalb des Bildschirmes kann nun die gewünschte Sprache ausgewählt werden, oder das Menü geöffnet werden, um das Zeitprogramm auf dem Bildschirm anzuzeigen und zu ändern.

- \* Der Fabrikant empfiehlt als Internetbrowser Google Chrome oder Mozilla Firefox.
- \*\* Falls Sie dieses über das Display der INFRA Zonen Regelung in dem Menü/Systemmenü/ Passwort geändert haben, geben Sie bitte das geänderte Passwort ein.

English

Nederlands

Français

Deutsch

## Status

	0	/	0	/	15	0	:	0	:	0
--	---	---	---	---	----	---	---	---	---	---

Zone	Temperatur	Sollwert	Betriebsmodus	Gerät	2. Stufe Störung		
Zone 1	22.8 °C	8.0 °C	Nacht	<input type="checkbox"/>	<input type="checkbox"/>	<input type="checkbox"/>	
Zone 2	---- °C	8.0 °C	Aus	<input type="checkbox"/>	<input type="checkbox"/>	<input type="checkbox"/>	
Zone 3	---- °C	8.0 °C	Aus	<input type="checkbox"/>	<input type="checkbox"/>	<input type="checkbox"/>	

## Einstellungen

Zone	Sollwert Tag	Sollwert Nacht	Betriebsmodus	Überstunden
Zone 1	17.5 °C	8.0 °C	Uhr (Auto)	0 min.
Zone 2	18.0 °C	8.0 °C	Aus	0 min.
Zone 3	18.0 °C	8.0 °C	Aus	0 min.

English

Nederlands

François

Deutsch

Zone 1

Mon	Din	Mit	Don	Fre	Sam	Son	Anfang	Ende
<input type="checkbox"/>	<input checked="" type="checkbox"/>	<input checked="" type="checkbox"/>	<input checked="" type="checkbox"/>	<input checked="" type="checkbox"/>	<input type="checkbox"/>	<input type="checkbox"/>	8 : 0	- 17 : 0
<input type="checkbox"/>	<input type="checkbox"/>	<input type="checkbox"/>	<input type="checkbox"/>	<input type="checkbox"/>	<input type="checkbox"/>	<input type="checkbox"/>	0 : 0	- 0 : 0
<input type="checkbox"/>	<input type="checkbox"/>	<input type="checkbox"/>	<input type="checkbox"/>	<input type="checkbox"/>	<input type="checkbox"/>	<input type="checkbox"/>	0 : 0	- 0 : 0
<input type="checkbox"/>	<input type="checkbox"/>	<input type="checkbox"/>	<input type="checkbox"/>	<input type="checkbox"/>	<input type="checkbox"/>	<input type="checkbox"/>	0 : 0	- 0 : 0
<input type="checkbox"/>	<input type="checkbox"/>	<input type="checkbox"/>	<input type="checkbox"/>	<input type="checkbox"/>	<input type="checkbox"/>	<input type="checkbox"/>	0 : 0	- 0 : 0
<input type="checkbox"/>	<input type="checkbox"/>	<input type="checkbox"/>	<input type="checkbox"/>	<input type="checkbox"/>	<input type="checkbox"/>	<input type="checkbox"/>	0 : 0	- 0 : 0
<input type="checkbox"/>	<input type="checkbox"/>	<input type="checkbox"/>	<input type="checkbox"/>	<input type="checkbox"/>	<input type="checkbox"/>	<input type="checkbox"/>	0 : 0	- 0 : 0

DE



Zone 2

Mon	Din	Mit	Don	Fre	Sam	Son	Anfang	Ende
<input checked="" type="checkbox"/>	<input checked="" type="checkbox"/>	<input checked="" type="checkbox"/>	<input checked="" type="checkbox"/>	<input checked="" type="checkbox"/>	<input type="checkbox"/>	<input type="checkbox"/>	8 : 0	- 17 : 0
<input type="checkbox"/>	<input type="checkbox"/>	<input type="checkbox"/>	<input type="checkbox"/>	<input type="checkbox"/>	<input type="checkbox"/>	<input type="checkbox"/>	0 : 0	- 0 : 0
<input type="checkbox"/>	<input type="checkbox"/>	<input type="checkbox"/>	<input type="checkbox"/>	<input type="checkbox"/>	<input type="checkbox"/>	<input type="checkbox"/>	0 : 0	- 0 : 0
<input type="checkbox"/>	<input type="checkbox"/>	<input type="checkbox"/>	<input type="checkbox"/>	<input type="checkbox"/>	<input type="checkbox"/>	<input type="checkbox"/>	0 : 0	- 0 : 0
<input type="checkbox"/>	<input type="checkbox"/>	<input type="checkbox"/>	<input type="checkbox"/>	<input type="checkbox"/>	<input type="checkbox"/>	<input type="checkbox"/>	0 : 0	- 0 : 0
<input type="checkbox"/>	<input type="checkbox"/>	<input type="checkbox"/>	<input type="checkbox"/>	<input type="checkbox"/>	<input type="checkbox"/>	<input type="checkbox"/>	0 : 0	- 0 : 0
<input type="checkbox"/>	<input type="checkbox"/>	<input type="checkbox"/>	<input type="checkbox"/>	<input type="checkbox"/>	<input type="checkbox"/>	<input type="checkbox"/>	0 : 0	- 0 : 0

Zone 3

Mon	Din	Mit	Don	Fre	Sam	Son	Anfang	Ende
<input type="checkbox"/>	<input checked="" type="checkbox"/>	<input checked="" type="checkbox"/>	<input checked="" type="checkbox"/>	<input checked="" type="checkbox"/>	<input type="checkbox"/>	<input type="checkbox"/>	8 : 0	- 17 : 0
<input type="checkbox"/>	<input type="checkbox"/>	<input type="checkbox"/>	<input type="checkbox"/>	<input type="checkbox"/>	<input type="checkbox"/>	<input type="checkbox"/>	0 : 0	- 0 : 0

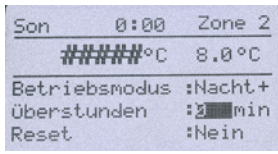
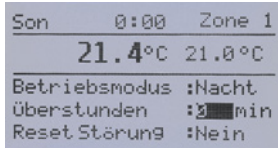
## 5.0 Störung

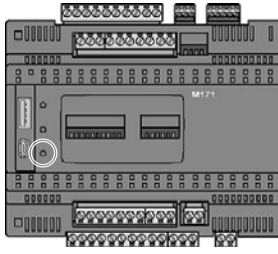
Abbildung	Meldung	Wo	Bedeutung
 <p>Son 0:00 Zone 2 #####°C 8.0°C Betriebsmodus :Nacht+ Überstunden :2 min Reset :Nein</p>	#####°C	Display	Kein Fühler angeschlossen.
 <p>Son 0:00 Zone 1 21.4°C 21.0°C Betriebsmodus :Nacht Überstunden :2 min Reset Störung :Nein</p>	Reset Störung: nein	Display	Es steht ein INFRA auf Störung. Über das Display kann nachverfolgt werden in welcher Zone die Störung ist.
	Das rechte Lämpchen leuchtet rot.	Display	Es steht ein INFRA auf Störung. Über das Display kann nachverfolgt werden in welcher Zone die Störung ist.
	-----°C	Internet-browser	Kein Fühler angeschlossen.
	Unterste Lampe blinkt <u>nicht</u> grün.	CANbus	Das Display und der Regler sind nicht miteinander verbunden.

## 6.0 Entsorgung

Falls die INFRA Zonen Regelung ersetzt oder entfernt wird, muss diese entsprechend der ländlichen oder örtlichen Verordnungen recycelt oder vernichtet werden.

## 7.0 Anhang

- [1] Anschlussplan Display
- [2] Modbus-Tabelle

# 8.0 Schaltplan

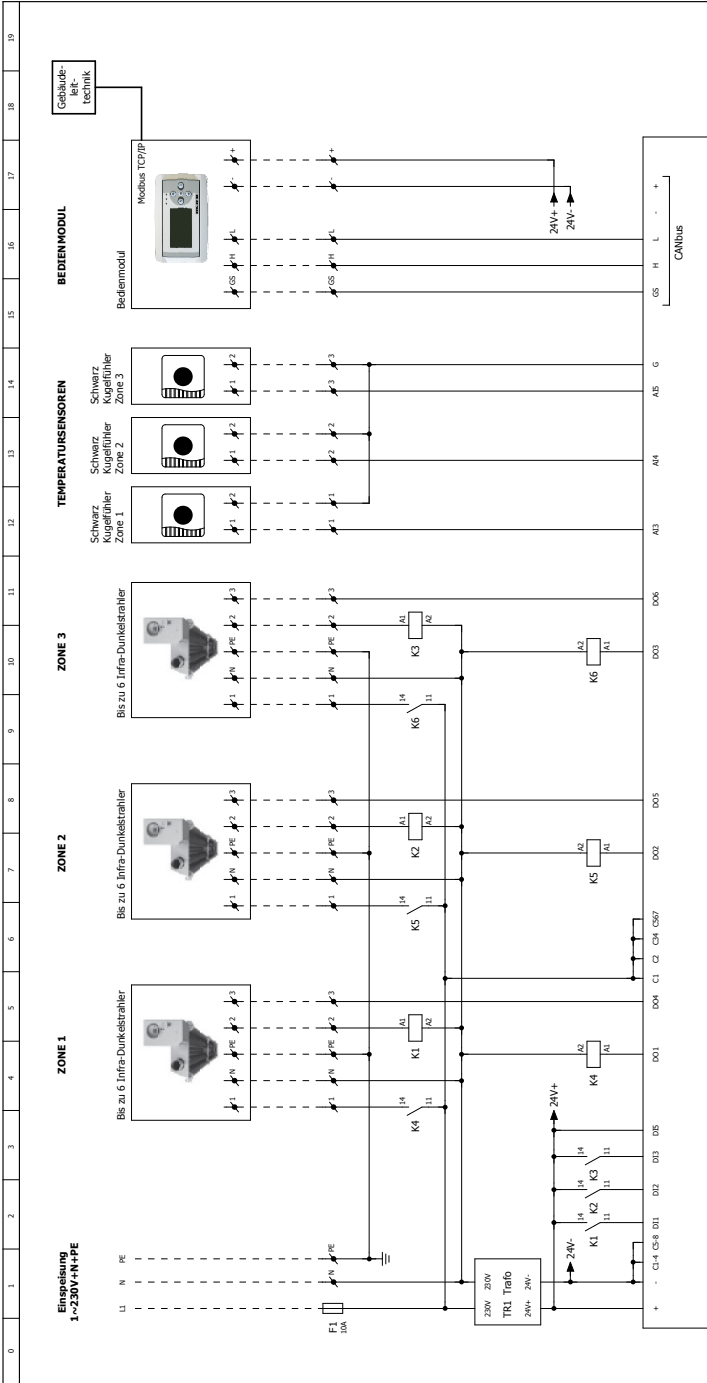

<p><b>Bis zu 6 Infra-Dunkelstrahler anschließen an 1 Zone</b></p> <p>Infra 1</p> <p>Infra 2</p> <p>Infra ...</p> <p>Infra 6</p>	<p><b>Verkabelung des Temperaturfühlers</b></p> <p>Länge:</p> <p>Diameter</p> <p>0,8 mm² = Max 80 Meter</p> <p>1,0 mm² = Max 100 Meter</p> <p>1,5 mm² = Max 150 Meter</p> <p>2,5 mm² = Max 250 Meter</p> <p><b>Vorsicht!</b> Für diese Anwendung muss man ein abgeschirmtes Kabel verwenden!</p>	<p><b>Anbringen des Temperaturfühlers</b></p> <p>Temperaturfühler direkt angestrahlt.</p> <p>Montageort 1,5 Meter über den Fußboden</p> <p>Wenn möglich 4 bis 5 Meter von INFRÖL</p>	<p><b>Relais:</b></p> <p>K1 - Störung Zone 1</p> <p>K2 - Störung Zone 2</p> <p>K3 - Störung Zone 3</p> <p>K4 - Wärmeanforderung Zone 1</p> <p>K5 - Wärmeanforderung Zone 2</p> <p>K6 - Wärmeanforderung Zone 3</p>	<p>Schalplan</p> <p>1:1/2016</p> <p>1:1</p>	<p>1-AB1500-DE</p> <p>1:1</p>
				<p>1 - Phase 230V</p> <p>N - Null</p> <p>PE - Erdung</p> <p>2 - 1te Stufe</p> <p>3 - 2te Stufe</p>	<p>Schalplan</p> <p>1:1/2016</p> <p>1:1</p>





# Lisez ce document avant de commencez l'installation et l'utilisation

## Attention!

Une installation imparfaite, un ajustement, une altération, une réparation peut entraîner des dommages matériels ou des blessures. Toutes les manipulations doivent être faites par un professionnel reconnu et qualifié. Si l'appareil n'est pas positionné comme dans les instructions, la garantie sera déclarée nulle. Cet appareil n'est pas fait pour être utilisé par des enfants ou des personnes avec un handicap physique, sensoriel ou mental ou qui manque d'expérience ou d'expertise à moins d'être supervisé ou avoir été instruit par quelqu'un qui est responsable de leur sécurité. Les enfants doivent être supervisés pour assurer qu'ils ne jouent pas avec l'appareil.

FR

## 1.0 Général

### 1.1 *Sujet à modification*

Le fabricant ne s'est pas engagé à constamment améliorer ses produits et se réserve le droit de faire des changements dans les caractéristiques sans en informer. Les détails techniques sont considérés comme corrects mais ne font pas partie d'un contrat où d'une garantie. Toutes les commandes sont acceptées selon nos termes de ventes générales et nos conditions de livraisons (disponible sur demandes).

Les informations contenues dans ce document sont sujet à changement sans préavis. La version la plus récente de ce guide est toujours disponible sur [www.markclimate.fr/telechargements](http://www.markclimate.fr/telechargements).

### 1.2 *Dangers généraux*

L'installation doit être effectuée selon les réglementations locales ou nationales. Le contrôleur de l'Infra zone doit donc être installé par un installateur compétent et qualifié, selon la législation nationale u internationale. Dans le cas d'une mauvaise installation, calibration; modification, maintenance ou réparation, la garantie ne s'appliquera pas.

## 2.0 Spécifications techniques

### 2.1 *Détails technique du contrôleur de l'Infra Zone*

Livraison: Contrôleur de panneau avec affichage externe

Dimensions de l'écran externe (Lxlxh) 160x98x43mm

Dimensions du contrôleur (Lxlxh) 376 x 300 x 120mm

Poids du contrôleur: 4800 grammes

Poids de l'écran: 206 grammes

Classe de protection: IP20

Montage de l'écran: intégré / installation sur le mur

Montage du contrôleur: Intégré ou sur le mur

Nombres de zones: 3

Nombre d'infra par zone: 6

Amplitude de température: De 2 à 40°C par 0.5°C

Options de contrôle Auto, jour continu, nuit continue, continuellement off

Affichage de la température nuit/jour avec affichage de la température actuelle sur l'écran.

Changement automatique de la période été/hiver.

Contrôle: on/off, élevé/faible ou modulation  
 Contrôle élevé/faible: Auto 1,2 ou 3k  
 Changement de période avec le programme hebdomadaire. (7 périodes différentes)  
 Timer d'heures supplémentaires 0-180 minutes par zone  
 Signal de dysfonctionnement du brûleur  
 Option de reset pour arrêter un dysfonctionnement du brûleur.  
 Code PIN pour modifier par exemple le changement de période et de température.  
 Langues: Anglais, Français, Allemand, et Néerlandais  
 Calibration du capteur de température: amplitude de -3°C à +3°C par 0.5°C  
 Alimentation: 230Vac / 50Hz.  
 Modbus TCP/IP  
 Serveur web intégré

## 2.2 Détails techniques pour capteur externe globale

Nom du type: RSTF PT1000  
 Code d'article : 06 29 082  
 • Résistance: PT1000  
 Dimensions (Lxlxh) 85 x 85 x 27mm (40 mm en incluant la hauteur du capteur)  
 Poids : 42 grammes  
 Connexion électrique : 0.14-1.5mm<sup>2</sup>  
 Degrés de protection: IP30

## 2.3 Tableau de résistance du capteur externe

PT1000					
°C	Ω	°C	Ω	°C	Ω
- 50	803	+ 20	1078	+ 90	1347
- 40	843	+ 30	1117	+ 100	1385
- 30	882	+ 40	1155	+ 110	1423
- 20	922	+ 50	1194	+ 120	1461
- 10	961	+ 60	1232	+ 130	1498
0	1000	+ 70	1271	+ 140	1536
+ 10	1039	+ 80	1309	+ 150	1573

## 2.4 Factory settings Zone Control Infra

Code du menu : 1000  
 Horaires de changements : Bloc 1 lu, ma, me, je, ve 08:00-17:00 hrs Bloc 2-7 off  
 Température de la pièce : Température de la pièce de jour 18°C  
 Température de la pièce de nuit 08°C  
 • Calibration : +0,0



## 3.0 Installation

### 3.1 Général

Le contrôleur de zone de l'infra est composé de:

- Un contrôleur avec ses terminaux de connexion et contrôleur
- Un écran externe pour afficher les informations
- Un capteur externe en globe

			
Un contrôleur	Un écran	Une plaque de montage au mur	Un capteur externe en globe
3003795			0629082

Après déballage, vérifiez si l'infra zone et si le capteur externe (si commandé) sont abîmés. Vérifiez la conformité du type/modèle et de l'alimentation.

### 3.2 Monter le contrôleur de zone Infra

Déterminer un endroit approprié pour monter le contrôleur de zone Infra (boîtier de contrôle, écran externe et capteur externe)

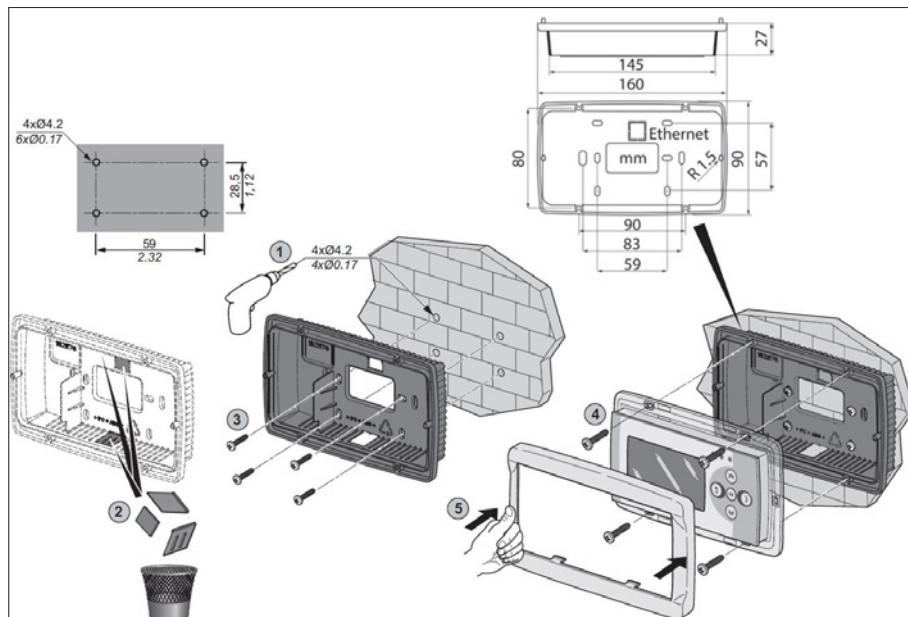

Placez le capteur externe dans un endroit sans courant d'air, non loin de l'unité et à approximativement 1.5 mètres du sol. Connectez le capteur aux terminaux appropriés dans le contrôleur de zone Infra Voir le tableau page suivante pour le diamètre correct du câble.

Assurez-vous que l'alimentation est coupée avant de connecter le câblage. Si ce n'est pas le cas, le courant doit être immédiatement coupé avant toute installation. Quand vous coupez l'alimentation de l'appareil, le manuel technique doit pris en compte.

Connectez le contrôleur de zone Infra selon le diagramme électrique à la fin du chapitre.

Diamètre	Longueur
0.8mm <sup>2</sup>	80 meter
1.0mm <sup>2</sup>	100 meter
1.5mm <sup>2</sup>	150 meter



Il est recommandé d'utiliser des câbles protégés

### 3.3 Vérifiez la connexion du contrôleur et de l'écran

Quand l'écran et le contrôleur sont connectés correctement via la connexion CAN-bus, la LED verte la plus basse clignotera.

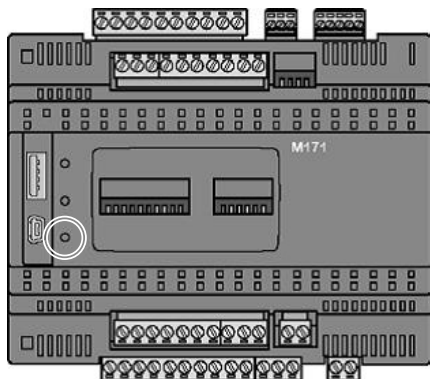





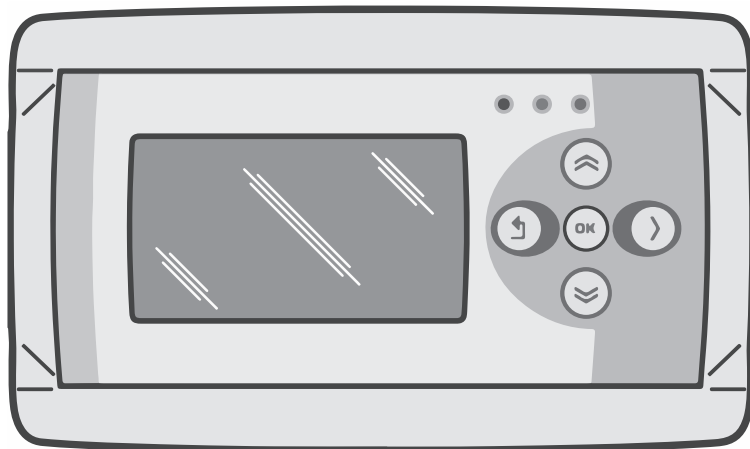

## 4.0 Commande et affichage

### 4.1 Les opérations



FR

Buttons	
	Défiler vers le haut Retourner à la page précédente Augmenter la valeur/ éditer les paramètres Suivant
	Défiler vers le bas Aller page suivante Baisser la valeur/ éditer les paramètres Aller au dernier
	Défiler vers le bas Passer au niveau/menu/paramètre suivant (Ouvrir le dossier, sous-dossier, paramètres des réglages) Ouvrir et confirmer les paramètres/ les paramètres des réglages Confirmer le changement des paramètres
	Déplacer le curseur vers la droite sur le mode de modification
	Quitter le menu/ retourner au menu précédent Déplacer le curseur vers la gauche sur le mode de modification (Appuyer et maintenir) quitter le monde de modification sans faire de changements
LED	LED verte/ orange/ rouge
	In case the red LED is lighting, it means an Infra heater is in fault condition. Through the display it can be seen in which zone this is.

## 4.2 Structure du menu

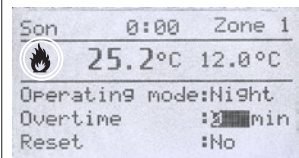
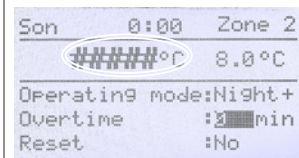
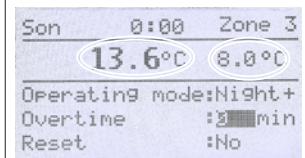
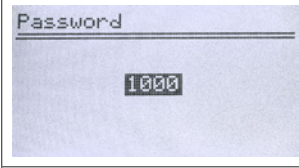
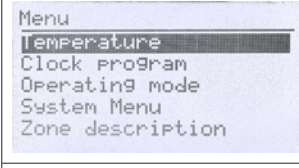
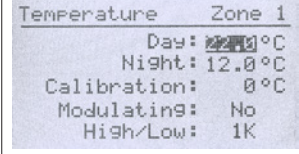
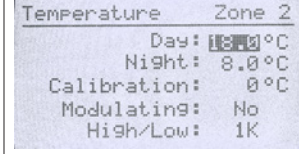
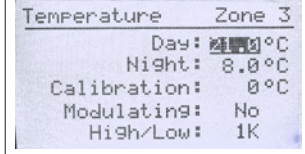
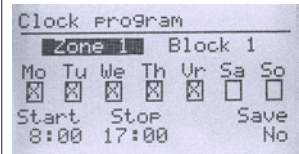
		
 <p>On: flamme Off : pas de flamme</p>	 <p>#####: Pas de capteur connecté</p>	 <p>13,6°C: Température Mesurée 8°C: Réglage</p>
		
		
		
<p>Régler la température désirée de jour, de nuit, la calibration, le contrôle de modulation, contrôle élevé ou bas pour chaque zone séparée.</p>		
		
<p><b>Programme de l'horloge</b> Régler le programme de l'horloge pour chaque zone Il est possible de contrôler trois zones et d'avoir 7 fonctions de temps par jour. Sélectionnez les jours, les heures de début et de fin</p>		

<pre> Operating mode Zone 1      auto Zone 2      night Zone 3      night </pre>		
<p><b>Le mode de fonctionnement</b>  Régler les modes opératoires pour chaque zone  -Auto (le programme de l'horloge sera suivi)  -Jour continu  -Nuit continue  -Off</p>		
<pre> System Menu Date/Time Language IP address Change Password Software Version </pre>		
<p><b>Menu système</b>  Dans ce menu, la date/ l'heure, la langue, l'adresse IP et le mot de passe peuvent être changé  La version de logiciel peut être affichée</p>		
<pre> Zone description Zone 1: Zone 1 Zone 2: Zone 2 Zone 3: Zone 3 </pre>		
<p><b>Description de zone</b>  Pour appeler les zones différemment au lieu de zone 1, 2, 3</p>		

#### 4.3 Menu système

<pre> System Menu Date/Time Language IP address Change Password Software Version </pre>		
<p><b>Menu système</b>  Dans ce menu, la date/ l'heure, la langue, l'adresse IP et le mot de passe peuvent être changé  La version de logiciel peut être affichée</p>		
<pre> Date/Time --/--/--  0:00:00 09/09/15  0:00:00 Tue                Save                         No </pre>		
<p><b>Date et heure</b>  Régler la date et l'heure actuelle</p>		

<pre> Language 1-English 2-Nederlands 3-Français 4-Deutsch Language <b>!</b> </pre>		
<p><b>Langues</b> Afficher la langue désirée (Anglais, Néerlandais, Français ou Allemand)</p>		
<pre> IP address IP 192.168.1.100 Sub 255.255.255.0 Save: No </pre>		
<p><b>Adresse IP</b> Régler l'adresse IP et le masque de sous réseau <i>Note:Après avoir changé l'adresse IP, le contrôleur va redémarrer</i></p>		
<pre> Change Password 1000 </pre>		
<p><b>Changer le mot de passe</b> Régler le changement de mot de passe pour avoir accès au menu ou à une page web Le mot de passe est 1000).</p>		
<pre> Software Version 1.0 </pre>		
<p><b>Version du logiciel</b> La version actuelle du logiciel.</p>		

#### 4.4 Opérer avec un ordinateur

L'unité peut être contrôlée avec un ordinateur

Connectez votre ordinateur au moyen d'un câble Ethernet à l'écran.

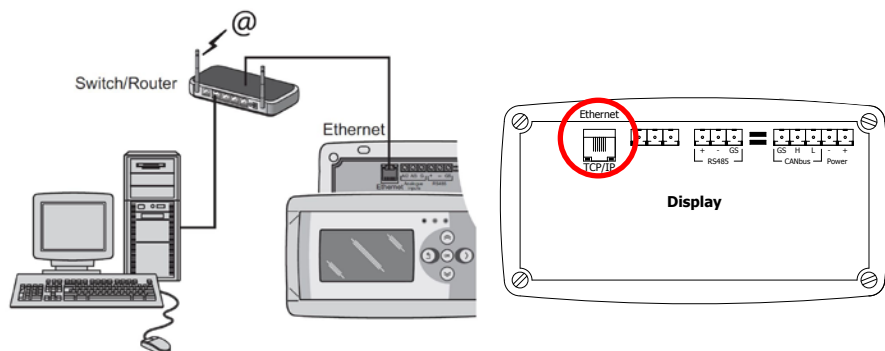

FR

Une fois que les deux sont connectés, lancez votre navigateur internet\* et entrez l'adresse IP (adresse par défaut : 192.168.1.100).

Quand il y a une connexion, un écran de connexion apparaît

Entrez le nom d'utilisateur et le mot de passe

Nom d'utilisateur: user

Mot de passe: 1000 (réglage d'usine)\*\*

Quand les informations de connexion ont été correctement entrées une page avec les statuts et détails apparaît dans votre navigateur. Via les onglets en haut de la page, la langue désirée peut être choisie ou le menu peut être ouvert pour voir ou changer les programmes.

\* Le fabricant conseille Google Chrome ou Mozilla Firefox

\*\* Dans le cas où vous avez changé via l'écran du contrôleur de zone de l'infra (menu/système/ changer de mot de passe) vous devez entrer le nouveau mot de passe

English

Nederlands

Français

Deutsch

## Status

	0	/	0	/	15	0	:	0	:	0
--	---	---	---	---	----	---	---	---	---	---

Zone	Temperature	Setpoint	Operating mode	Unit	High	Error
Zone 1	22.7 °C	8.0 °C	Night	<input type="checkbox"/>	<input type="checkbox"/>	<input type="checkbox"/>
Zone 2	---- °C	8.0 °C	Off	<input type="checkbox"/>	<input type="checkbox"/>	<input type="checkbox"/>
Zone 3	---- °C	8.0 °C	Off	<input type="checkbox"/>	<input type="checkbox"/>	<input type="checkbox"/>

## Settings

Zone	Setpoint Day	Setpoint Night	Operating mode	Overtime
Zone 1	17.5 °C	8.0 °C	Clock(Auto)	0 min.
Zone 2	18.0 °C	8.0 °C	Off	0 min.
Zone 3	18.0 °C	8.0 °C	Off	0 min.



4.4.2 Menu du programme horloge

English

Nederlands

François

Deutsch

Zone 1

Mon	Tue	Wen	Thu	Vri	Sat	Sun	Start	Stop
<input type="checkbox"/>	<input checked="" type="checkbox"/>	<input checked="" type="checkbox"/>	<input checked="" type="checkbox"/>	<input checked="" type="checkbox"/>	<input type="checkbox"/>	<input type="checkbox"/>	8 : 0	- 17 : 0
<input type="checkbox"/>	<input type="checkbox"/>	<input type="checkbox"/>	<input type="checkbox"/>	<input type="checkbox"/>	<input type="checkbox"/>	<input type="checkbox"/>	0 : 0	- 0 : 0
<input type="checkbox"/>	<input type="checkbox"/>	<input type="checkbox"/>	<input type="checkbox"/>	<input type="checkbox"/>	<input type="checkbox"/>	<input type="checkbox"/>	0 : 0	- 0 : 0
<input type="checkbox"/>	<input type="checkbox"/>	<input type="checkbox"/>	<input type="checkbox"/>	<input type="checkbox"/>	<input type="checkbox"/>	<input type="checkbox"/>	0 : 0	- 0 : 0
<input type="checkbox"/>	<input type="checkbox"/>	<input type="checkbox"/>	<input type="checkbox"/>	<input type="checkbox"/>	<input type="checkbox"/>	<input type="checkbox"/>	0 : 0	- 0 : 0
<input type="checkbox"/>	<input type="checkbox"/>	<input type="checkbox"/>	<input type="checkbox"/>	<input type="checkbox"/>	<input type="checkbox"/>	<input type="checkbox"/>	0 : 0	- 0 : 0
<input type="checkbox"/>	<input type="checkbox"/>	<input type="checkbox"/>	<input type="checkbox"/>	<input type="checkbox"/>	<input type="checkbox"/>	<input type="checkbox"/>	0 : 0	- 0 : 0

FR



Zone 2

Mon	Tue	Wen	Thu	Vri	Sat	Sun	Start	Stop
<input checked="" type="checkbox"/>	<input checked="" type="checkbox"/>	<input checked="" type="checkbox"/>	<input checked="" type="checkbox"/>	<input checked="" type="checkbox"/>	<input type="checkbox"/>	<input type="checkbox"/>	8 : 0	- 17 : 0
<input type="checkbox"/>	<input type="checkbox"/>	<input type="checkbox"/>	<input type="checkbox"/>	<input type="checkbox"/>	<input type="checkbox"/>	<input type="checkbox"/>	0 : 0	- 0 : 0
<input type="checkbox"/>	<input type="checkbox"/>	<input type="checkbox"/>	<input type="checkbox"/>	<input type="checkbox"/>	<input type="checkbox"/>	<input type="checkbox"/>	0 : 0	- 0 : 0
<input type="checkbox"/>	<input type="checkbox"/>	<input type="checkbox"/>	<input type="checkbox"/>	<input type="checkbox"/>	<input type="checkbox"/>	<input type="checkbox"/>	0 : 0	- 0 : 0
<input type="checkbox"/>	<input type="checkbox"/>	<input type="checkbox"/>	<input type="checkbox"/>	<input type="checkbox"/>	<input type="checkbox"/>	<input type="checkbox"/>	0 : 0	- 0 : 0
<input type="checkbox"/>	<input type="checkbox"/>	<input type="checkbox"/>	<input type="checkbox"/>	<input type="checkbox"/>	<input type="checkbox"/>	<input type="checkbox"/>	0 : 0	- 0 : 0
<input type="checkbox"/>	<input type="checkbox"/>	<input type="checkbox"/>	<input type="checkbox"/>	<input type="checkbox"/>	<input type="checkbox"/>	<input type="checkbox"/>	0 : 0	- 0 : 0

Zone 3

Mon	Tue	Wen	Thu	Vri	Sat	Sun	Start	Stop
<input type="checkbox"/>	<input checked="" type="checkbox"/>	<input checked="" type="checkbox"/>	<input checked="" type="checkbox"/>	<input checked="" type="checkbox"/>	<input type="checkbox"/>	<input type="checkbox"/>	8 : 0	- 17 : 0
<input type="checkbox"/>	<input type="checkbox"/>	<input type="checkbox"/>	<input type="checkbox"/>	<input type="checkbox"/>	<input type="checkbox"/>	<input type="checkbox"/>	0 : 0	- 0 : 0

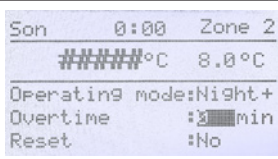
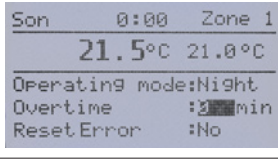
## 5.0 Dysfonctionnements

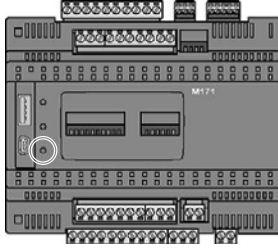
Image	Alerte	Où?	Signification
	#####°C	écran	Pas de capteur connecté
	Erreur de redémarrage Non	écran	L'infra a un problème La zone endommagée est affichée sur l'écran
	La LED de droite est allumé en rouge	écran	L'infra a un problème La zone endommagée est affichée sur l'écran
	----- °C	Internet	Pas de capteur connecté
	La LED la plus basse ne clignote pas en vert	CANBus	L'écran et le contrôleur ne sont pas connecté l'un à l'autre

## 6.0 Le recyclage

Quand le contrôleur de zone Infra est remplacé ou retiré, il doit être recyclé ou mis dans une décharge selon les réglementations nationales ou locales.

## 7.0 Accessoires

[1] affichage du diagramme électrique

[2] liste Modbus

# 8.0 Diagramme électrique

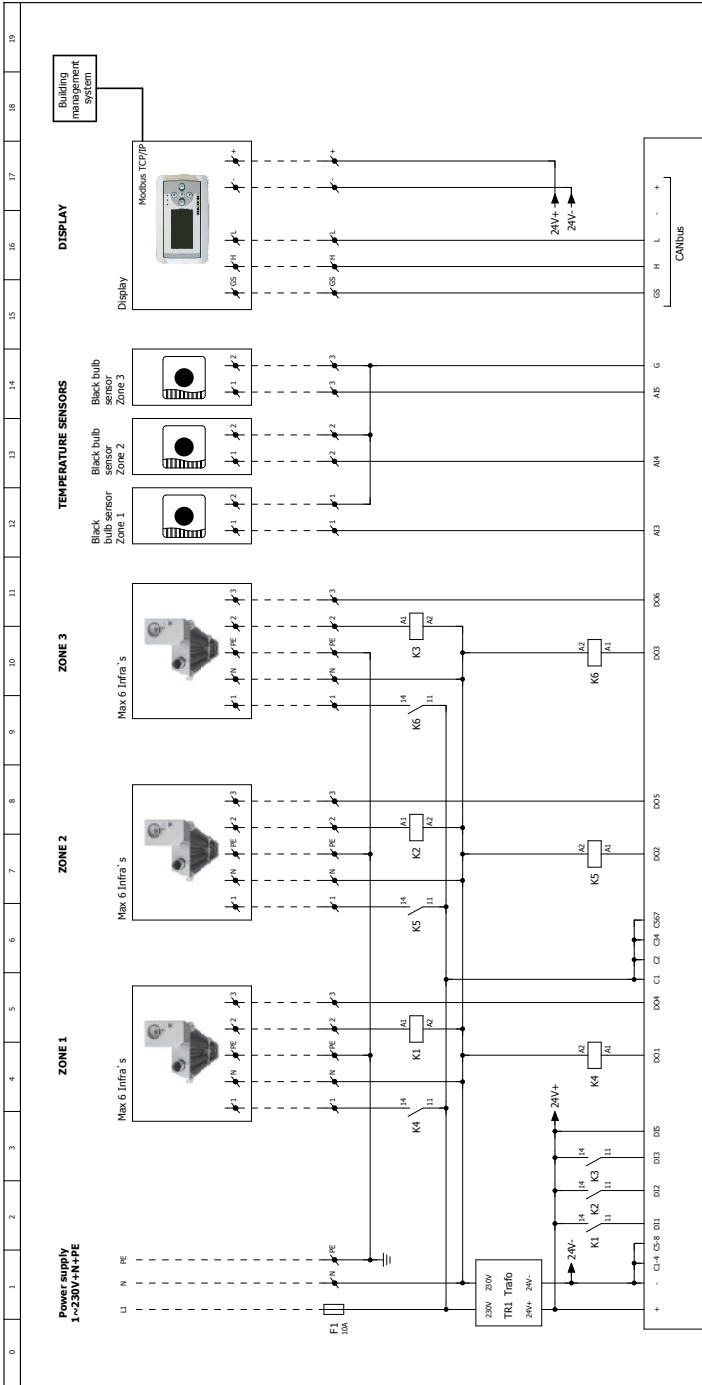

<p><b>Connect maximum of 6 Infrira to 1 zone.</b></p> <p>Infrira1</p> <p>Infrira2</p> <p>Infrira...</p> <p>Infrira6</p>	<p><b>Cabling temperature sensors</b></p> <p><b>Length:</b></p> <ul style="list-style-type: none"> <li>0,8 mm<sup>2</sup> = max 80 metres</li> <li>1,0 mm<sup>2</sup> = max 100 metres</li> <li>1,5 mm<sup>2</sup> = max 150 metres</li> <li>2,5 mm<sup>2</sup> = max 250 metres</li> </ul> <p><b>⚠ Attention</b> Use a shielded cable for this purpose!</p>	<p><b>Assembly of external globe sensor:</b></p> <p>Temperature sensor draught-free within view of the appliance</p> <p>Distance of 1.5 meter from the floor</p> <p>If possible place 4 to 5 metres from Infrira.</p>	<p><b>Relays:</b></p> <ul style="list-style-type: none"> <li>K1 - Failure zone 1</li> <li>K2 - Failure zone 2</li> <li>K3 - Failure zone 3</li> <li>K4 - Heat demand zone 1</li> <li>K5 - Heat demand zone 2</li> <li>K6 - Heat demand zone 3</li> </ul>	<p>Electrical drawing</p> <p>Doc. 1100</p>	<p>Year</p> <p>1/12/2016</p>	<p>Drawn</p> <p>AC/ST</p>	<p>1-AB1500-EN</p>
				<p>Zone control Infrira</p>	<p>Version</p> <p>3.0.0/262</p>	<p>Type</p> <p>1.1</p>	<p>10</p>





# Lees dit document door voordat u begint met de installatie en ingebruikname

## Waarschuwing!

Een foutief uitgevoerde installatie, wijziging of reparatie kan leiden tot materiële schade of verwondingen. Alle werkzaamheden moeten door erkende, gekwalificeerde vakmensen worden uitgevoerd. Indien het toestel niet volgens voorschrift wordt geplaatst, vervalt de garantie. Dit apparaat is niet bedoeld voor gebruik door personen (inclusief kinderen) met verminderde lichamelijke, zintuiglijke of geestelijke vermogens, of gebrek aan ervaring en kennis, tenzij zij onder toezicht staan of worden geïnstrueerd over het gebruik van het apparaat door een persoon die verantwoordelijk is voor hun veiligheid. Kinderen moeten gecontroleerd worden om ervoor te zorgen dat ze niet met het apparaat spelen.

NL

## 1.0 Algemeen

### 1.1 Wijzigingen voorbehouden

De fabrikant streeft continu naar verbetering van haar producten, en behoudt zich het recht voor om zonder voorafgaande kennisgeving veranderingen in de specificaties aan te brengen. De technische details worden als correct verondersteld maar vormen geen basis voor een contract of garantie. Alle orders worden geaccepteerd onder de standaard condities van onze algemene verkoop- en leveringsvoorwaarden (op aanvraag leverbaar). De informatie in dit document kan zonder voorafgaande kennisgeving worden gewijzigd. De meest recente versie van deze handleiding is altijd beschikbaar op [www.mark.nl/downloads](http://www.mark.nl/downloads).

### 1.2 Algemene waarschuwingen

De installatie moet voldoen aan de geldende plaatselijke en/of landelijke voorschriften. Laat daarom de Infra zone regeling door een vakbekwaam en gekwalificeerd installateur installeren met inachtneming van de nationale en internationale regelgeving. Bij een foutieve installatie, afregeling, wijziging, onderhoudsafhandeling of herstelling vervalt de garantie.

## 2.0 Technische gegevens

### 2.1 Technische gegevens Infra zone regeling

- Levering: Schakelkast met externe display
- Afmeting extern display (bxhxd): 160x98x43mm
- Afmeting Schakelkast (bxhxd): 376 x 300 x 120mm
- Gewicht schakelkast: 4800 gram
- Gewicht display: 206 gram
- Beschermingsklasse: IP20
- Montage display: Inbouw / wandmontage
- Montage Schakelkast: Opbouw / wandmontage
- Aantal zones: 3

- Aantal Infra's per zone: 6
- Instelbereik temperatuur: 2...40°C per 0,5°C.
- Bedrijfswijze keuze: Automatisch, continu dag, continu nacht of continu uit
- Dag-/nachttemperatuur bewaking met aflezing van de actuele ruimtetemperatuur op het display
- Automatische zomer-/wintertijdaanpassing.
- Regeling: aan/uit, hoog/laag of modulerend
- Hoog/laag regeling: Automatisch 1, 2 of 3K
- Schakelklok met weekprogramma (7 schakelblokken)
- Overwerktimer: 0-180 min per zone.
- Signalering van een brander storing per zone.
- Resetmogelijkheid voor ontgrendeling van een brander storing per zone.
- Pincodebeveiliging om o.a. de schakeltijden en temperaturen te kunnen wijzigen.
- Talen: Engels, Frans, Duits en Nederlands
- IJking temperatuursensor: instelbaar van -3°C tot +3°C per 0,5°C instelbaar
- Voeding: 230Vac / 50Hz.
- Modbus TCP/IP
- Ingebouwde webserver

## 2.2 Technische gegevens externe zwarte bol voeler

- Type aanduiding : RSTF PT1000
- Artikelnummer : 06 29 082
- Weerstand : PT1000
- Afmeting (bxhxd) : 85 x 85 x 27mm (40 mm incl. hoogte zwarte bol)
- Gewicht : 42 gram
- Elektrische aansluiting : 0.14-1.5mm<sup>2</sup>
- Beschermingsgraad : IP30

## 2.3 Weerstandstabel externe zwarte bol voeler

PT1000					
°C	Ω	°C	Ω	°C	Ω
- 50	803	+ 20	1078	+ 90	1347
- 40	843	+ 30	1117	+ 100	1385
- 30	882	+ 40	1155	+ 110	1423
- 20	922	+ 50	1194	+ 120	1461
- 10	961	+ 60	1232	+ 130	1498
0	1000	+ 70	1271	+ 140	1536
+ 10	1039	+ 80	1309	+ 150	1573

## 2.4 Fabrieksinstellingen Zone Regeling Infra



- Menu code : 1000
- Schakeltijden : Block 1 MA, DI, WO, DO, VR 08:00-17:00 uur  
Block 2 t/m 7 uit
- Ruimtetemperatuur : Dagtemperatuur 18°C  
Nachttemperatuur 08°C
- IJking : +0.0

### 3.0 Installatie

#### 3.1 Algemeen

De Infra zone regeling bestaat uit:

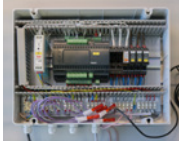
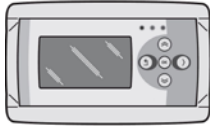
- Een schakelkast met daarin de aansluitklemmen en regelaar;
- Een externe display voor bediening van de regeling;
- Externe zwarte bol voeler(s)

			
Schakelkast	Display	Wandmontageplaat	Zwarte bol voeler
3003795			0629082

Controleer na het uitpakken de Infra zone regeling en de mee bestelde externe zwarte bol voeler op beschadiging. Controleer op juistheid van het type/model en de elektrische spanning.

#### 3.2 Montage Infra zone regeling

Bepaal een geschikte plaats om de Infra zone regeling (Schakelkast, externe display en de zwarte

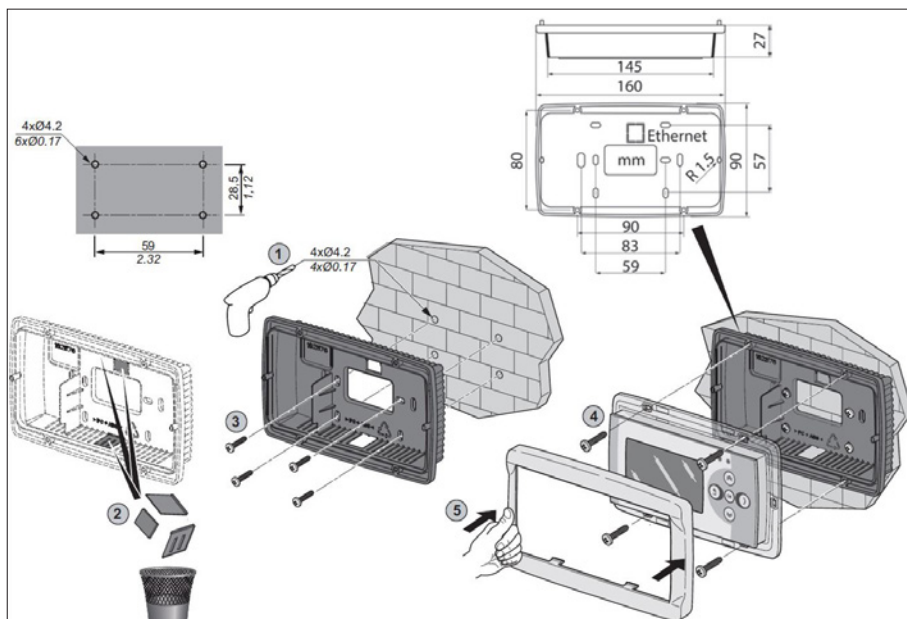

bol voeler(s)) te monteren.

Plaats de externe zwarte bol voeler tochtvrij, in het zicht van het toestel op een hoogte van ca. 1.5m vanaf de vloer. En sluit de voeler aan op de daarvoor bestemde klemmen in de Infra zone regeling. Zie de tabel op de volgende pagina voor de juiste kabeldiameter.

Controleer voor het aansluiten van de bekabeling of de spanning is uitgeschakeld. Indien dit niet het geval is dient eerst de spanning te worden uitgeschakeld voordat u verder gaat. Bij het uitschakelen van de spanning van het aan te sluiten toestel, dient hierbij ook het technisch boek/bedieningshandleiding van het toestel in acht te worden genomen.

Sluit de Infra zone regeling volgens het elektrische schema aan, welke achterin dit technisch boek staan.

Diameter	Lengte
0.8mm <sup>2</sup>	80 meter
1.0mm <sup>2</sup>	100 meter
1.5mm <sup>2</sup>	150 meter

 Geadviseerd wordt om hiervoor een afgeschermd kabel te gebruiken.

### 3.3 Controle verbinding regelaar display

Wanneer het display en de regelaar op de juiste wijze met elkaar zijn verbonden via de CAN-bus aansluitingen zal de onderste groene LED knipperen.

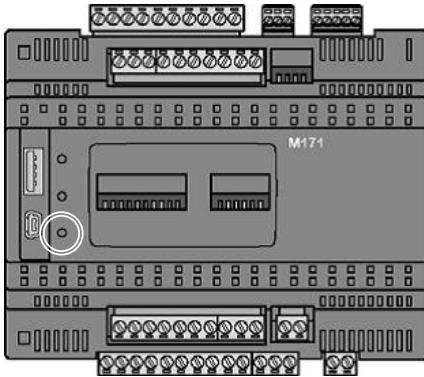







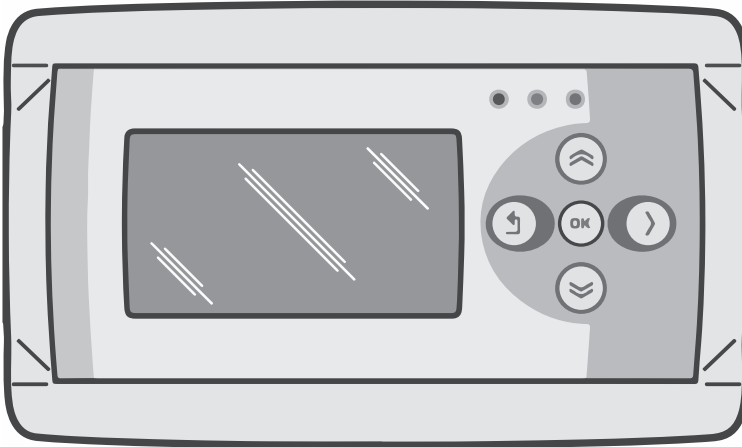

## 4.0 Bediening en display

### 4.1 Bediening



NL

Knoppen	
	<ul style="list-style-type: none"> <li>• Scroll omhoog</li> <li>• Terugkeren naar vorige pagina</li> <li>• Verhoog waarde / wijzig een instelling</li> <li>• Ga naar volgende</li> </ul>
	<ul style="list-style-type: none"> <li>• Scroll omlaag</li> <li>• Ga naar volgende pagina</li> <li>• Verlaag waarde / wijzig een instelling</li> <li>• Ga naar vorige</li> </ul>
	<ul style="list-style-type: none"> <li>• Scroll down</li> <li>• Ga naar volgende level/menu/edit mode (open folder, subfolder, parameter setting)</li> <li>• Openen en bevestigen van de instelling/parameter setting.</li> <li>• Bevestigen van de wijziging/instelling</li> </ul>
	<ul style="list-style-type: none"> <li>• Verplaats cursor naar rechts in de edit mode</li> </ul>
	<ul style="list-style-type: none"> <li>• Exit menu pagina / ga terug naar vorig menu</li> <li>• Verplaats cursor naar links in de edit mode</li> <li>• (Druk en houd vast) Verlaat edit mode zonder wijzigingen aan te brengen</li> </ul>

Led's	Led groen / oranje / rood
	Indien de rode led oplicht betekent dit dat er een Infra op storing staat. Via het display is te zien in welke zone dit is.

## 4.2 Menustructuur

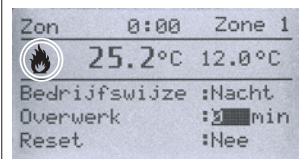
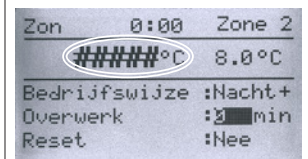
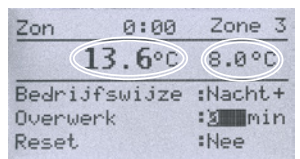
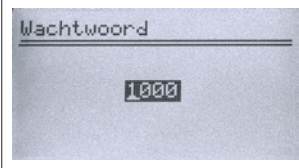
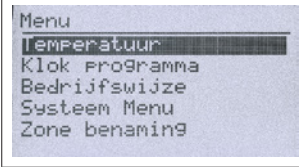
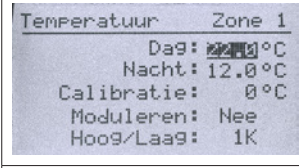
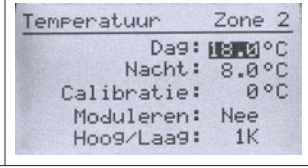
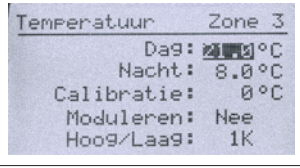
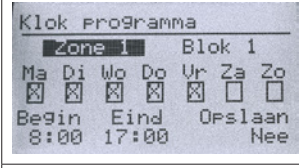
		
 <p>Aan: vlam Uit: geen vlam</p>	 <p>#####: Geen voeler aangesloten.</p>	 <p>13.6 °C: Gemeten temperatuur. 8.0 °C: Setpoint.</p>
		
		
		
<p>Instellen van de gewenste dagtemperatuur, nachttemperatuur, calibratie, regeling modulerend, hoog/laag regeling voor elke zone apart.</p>		
		
<p><b>Klokprogramma</b>          Instellen van het klokprogramma per zone.          Van wanneer tot wanneer moet de regelaar naar dagtemperatuur schakelen.          Per zone mogelijkheid voor het programmeren van 7 programmablokken.          Per blok selecteren van welke weekdays en begin en eindtijd.</p>		

<pre> Bedrijfswijze Zone 1      auto Zone 2      nacht Zone 3      nacht </pre>		
<p><b>Bedrijfswijze</b></p> <p>Per zone kan hier ingesteld worden welke bedrijfswijze gevolgd moet worden</p> <ul style="list-style-type: none"> <li>- auto (klokprogramma wordt gevolgd),</li> <li>- continu dag,</li> <li>- continu nacht,</li> <li>- uit</li> </ul>		
<pre> Systeem Menu Datum/Tijd Taal IP adres Wachtwoord wijzigen Software Versie </pre>		
<p><b>Systeem menu</b></p> <p>In dit menu kunnen de datum/tijd, taalkeuze, IP adres, Wachtwoord worden gewijzigd. En kan de software versie worden opgevraagd.</p>		
<pre> Zone benaming Zone 1: Zone yy Zone 2: Zone 2 Zone 3: Zone 3 </pre>		
<p><b>Zone benaming</b></p> <p>Elke zone een naam geven standaard ingesteld zone 1, zone 2, zone 3.</p>		

### 4.3 Het systeem menu

<pre> Systeem Menu Datum/Tijd Taal IP adres Wachtwoord wijzigen Software Versie </pre>		
<p><b>Systeem menu</b></p> <p>In dit menu kunnen de datum/tijd, taalkeuze, IP adres, Wachtwoord worden gewijzigd. En kan de software versie worden opgevraagd.</p>		
<pre> Datum/Tijd --/--/--  0:00:00 29/09/15  0:00:00 Din       Opslaan           Nee </pre>		
<p><b>Datum/tijd</b></p> <p>Instellen van de actuele datum en tijd.</p>		

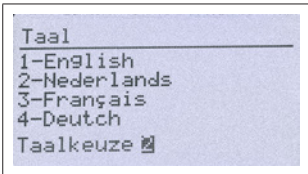
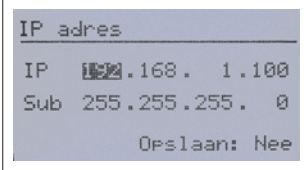
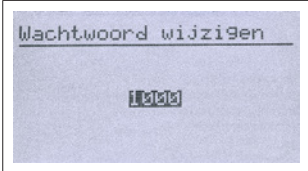
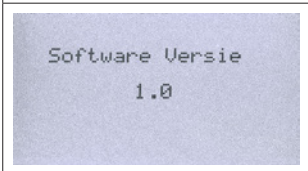
		
<p><b>Taal</b> Gewenste taal selecteren (English, Nederlands, Français, Deutsch).</p>		
		
<p><b>IP adres</b> Instellen IP-adres en Subnetmask <i>Opmerking: Na het opslaan van het IP adres zal de regelaar opnieuw opstarten.</i></p>		
		
<p><b>Wachtwoord wijzigen</b> Hier kan ingestelde wachtwoord gewijzigd worden om in het menu te komen of om via de webpagina in te loggen. (Wachtwoord standaard ingesteld op 1000).</p>		
		
<p><b>Software versie</b> De actuele softwareversie</p>		

#### 4.4 Bediening met een computer

De unit kan met een PC of laptop worden bediend.

Verbind de PC of laptop d.m.v. een ethernet aansluiting op het display.

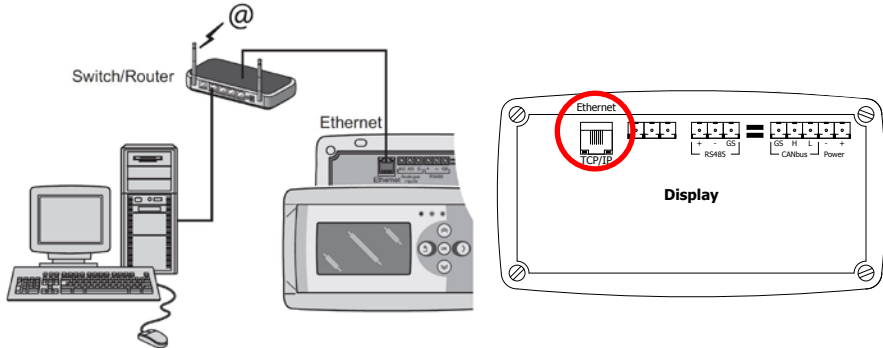

NL

Nadat u de verbinding heeft gemaakt start u uw internetbrowser\* op en voert u het IP adres in.  
(Standaard ingestelde adres: 192.168.1.100)

Wanneer u verbinding heeft zal een inlogscherm in beeld verschijnen.  
Voer de gebruikersnaam en het wachtwoord in.

Gebruikersnaam: user  
Wachtwoord: 1000 (standaard af fabriek) \*\*

Wanneer de inloggegevens juist zijn ingevoerd verschijnt het tabblad status/instellingen in uw browser. Via de tabbladen aan de bovenzijde van het scherm kan vervolgens de gewenste taal worden gekozen of het menu worden geopend om het klokprogramma op het scherm te tonen en te wijzigen.

- \* De fabrikant adviseert als internetbrowser Google Chrome of Mozilla Firefox.
- \*\* Indien u deze heeft gewijzigd via het Display van de Infra zone regeling in het menu/ systeemmenu/wachtwoord wijzigen dient u het gewijzigde wachtwoord in te voeren.

English

Nederlands

Français

Deutsch

## Status

	0	/	0	/	15		0	:	0	:	0
--	---	---	---	---	----	--	---	---	---	---	---

Zone	Temperatuur	Setpoint	Bedrijfswijze	Unit	Hoog	Storing
Zone 1	22.7 °C	8.0 °C	Nacht	<input type="checkbox"/>	<input type="checkbox"/>	<input type="checkbox"/>
Zone 2	----- °C	8.0 °C	Uit	<input type="checkbox"/>	<input type="checkbox"/>	<input type="checkbox"/>
Zone 3	----- °C	8.0 °C	Uit	<input type="checkbox"/>	<input type="checkbox"/>	<input type="checkbox"/>

## Instellingen

Zone	Setpoint dag	Setpoint nacht	Bedrijfswijze	Overwerktijd
Zone 1	17.5 °C	8.0 °C	Klok (auto)	0 min.
Zone 2	18.0 °C	8.0 °C	Uit	0 min.
Zone 3	18.0 °C	8.0 °C	Uit	0 min.

4.4.2 Menu klokprogramma

English

Nederlands

François

Deutsch

Zone 1

Maa	Din	Woe	Don	Vri	Zat	Zon	Start	Stop
<input type="checkbox"/>	<input checked="" type="checkbox"/>	<input checked="" type="checkbox"/>	<input checked="" type="checkbox"/>	<input checked="" type="checkbox"/>	<input type="checkbox"/>	<input type="checkbox"/>	8 : 0	- 17 : 0
<input type="checkbox"/>	<input type="checkbox"/>	<input type="checkbox"/>	<input type="checkbox"/>	<input type="checkbox"/>	<input type="checkbox"/>	<input type="checkbox"/>	0 : 0	- 0 : 0
<input type="checkbox"/>	<input type="checkbox"/>	<input type="checkbox"/>	<input type="checkbox"/>	<input type="checkbox"/>	<input type="checkbox"/>	<input type="checkbox"/>	0 : 0	- 0 : 0
<input type="checkbox"/>	<input type="checkbox"/>	<input type="checkbox"/>	<input type="checkbox"/>	<input type="checkbox"/>	<input type="checkbox"/>	<input type="checkbox"/>	0 : 0	- 0 : 0
<input type="checkbox"/>	<input type="checkbox"/>	<input type="checkbox"/>	<input type="checkbox"/>	<input type="checkbox"/>	<input type="checkbox"/>	<input type="checkbox"/>	0 : 0	- 0 : 0
<input type="checkbox"/>	<input type="checkbox"/>	<input type="checkbox"/>	<input type="checkbox"/>	<input type="checkbox"/>	<input type="checkbox"/>	<input type="checkbox"/>	0 : 0	- 0 : 0
<input type="checkbox"/>	<input type="checkbox"/>	<input type="checkbox"/>	<input type="checkbox"/>	<input type="checkbox"/>	<input type="checkbox"/>	<input type="checkbox"/>	0 : 0	- 0 : 0

NL



Zone 2

Maa	Din	Woe	Don	Vri	Zat	Zon	Start	Stop
<input checked="" type="checkbox"/>	<input checked="" type="checkbox"/>	<input checked="" type="checkbox"/>	<input checked="" type="checkbox"/>	<input checked="" type="checkbox"/>	<input type="checkbox"/>	<input type="checkbox"/>	8 : 0	- 17 : 0
<input type="checkbox"/>	<input type="checkbox"/>	<input type="checkbox"/>	<input type="checkbox"/>	<input type="checkbox"/>	<input type="checkbox"/>	<input type="checkbox"/>	0 : 0	- 0 : 0
<input type="checkbox"/>	<input type="checkbox"/>	<input type="checkbox"/>	<input type="checkbox"/>	<input type="checkbox"/>	<input type="checkbox"/>	<input type="checkbox"/>	0 : 0	- 0 : 0
<input type="checkbox"/>	<input type="checkbox"/>	<input type="checkbox"/>	<input type="checkbox"/>	<input type="checkbox"/>	<input type="checkbox"/>	<input type="checkbox"/>	0 : 0	- 0 : 0
<input type="checkbox"/>	<input type="checkbox"/>	<input type="checkbox"/>	<input type="checkbox"/>	<input type="checkbox"/>	<input type="checkbox"/>	<input type="checkbox"/>	0 : 0	- 0 : 0
<input type="checkbox"/>	<input type="checkbox"/>	<input type="checkbox"/>	<input type="checkbox"/>	<input type="checkbox"/>	<input type="checkbox"/>	<input type="checkbox"/>	0 : 0	- 0 : 0
<input type="checkbox"/>	<input type="checkbox"/>	<input type="checkbox"/>	<input type="checkbox"/>	<input type="checkbox"/>	<input type="checkbox"/>	<input type="checkbox"/>	0 : 0	- 0 : 0

Zone 3

Maa	Din	Woe	Don	Vri	Zat	Zon	Start	Stop
<input type="checkbox"/>	<input checked="" type="checkbox"/>	<input checked="" type="checkbox"/>	<input checked="" type="checkbox"/>	<input checked="" type="checkbox"/>	<input type="checkbox"/>	<input type="checkbox"/>	8 : 0	- 17 : 0
<input type="checkbox"/>	<input type="checkbox"/>	<input type="checkbox"/>	<input type="checkbox"/>	<input type="checkbox"/>	<input type="checkbox"/>	<input type="checkbox"/>	0 : 0	- 0 : 0

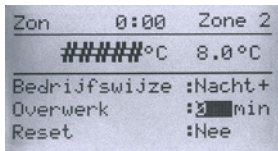
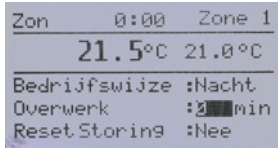
## 5.0 Storingen

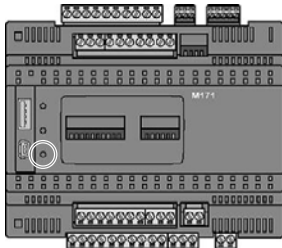
Afbeelding	Melding	Waar	Betekenis
	#####°C	Display	Geen voeler aangesloten.
	Reset error: No	Display	Er staat een Infra op storing. Via het display is te zien in welke zone dit is.
	De rechter LED brandt rood	Display	Er staat een Infra op storing. Via het display is te zien in welke zone dit is.
	----- °C	Internet-browser	Geen voeler aangesloten.
	Onderste LED knippert <u>niet</u> groen.	CANbus	Het display en de regelaar zijn niet met elkaar verbonden.

## 6.0 Afdanken

Wanneer de Infra zone regeling wordt vervangen of verwijderd dient deze conform landelijke en/of plaatselijke verordeningen te worden gerecycled of vernietigd.

## 7.0 Bijlagen

- [1] Aansluitschema display
- [2] Modbus-lijst



# 8.0 Elektrisch schema

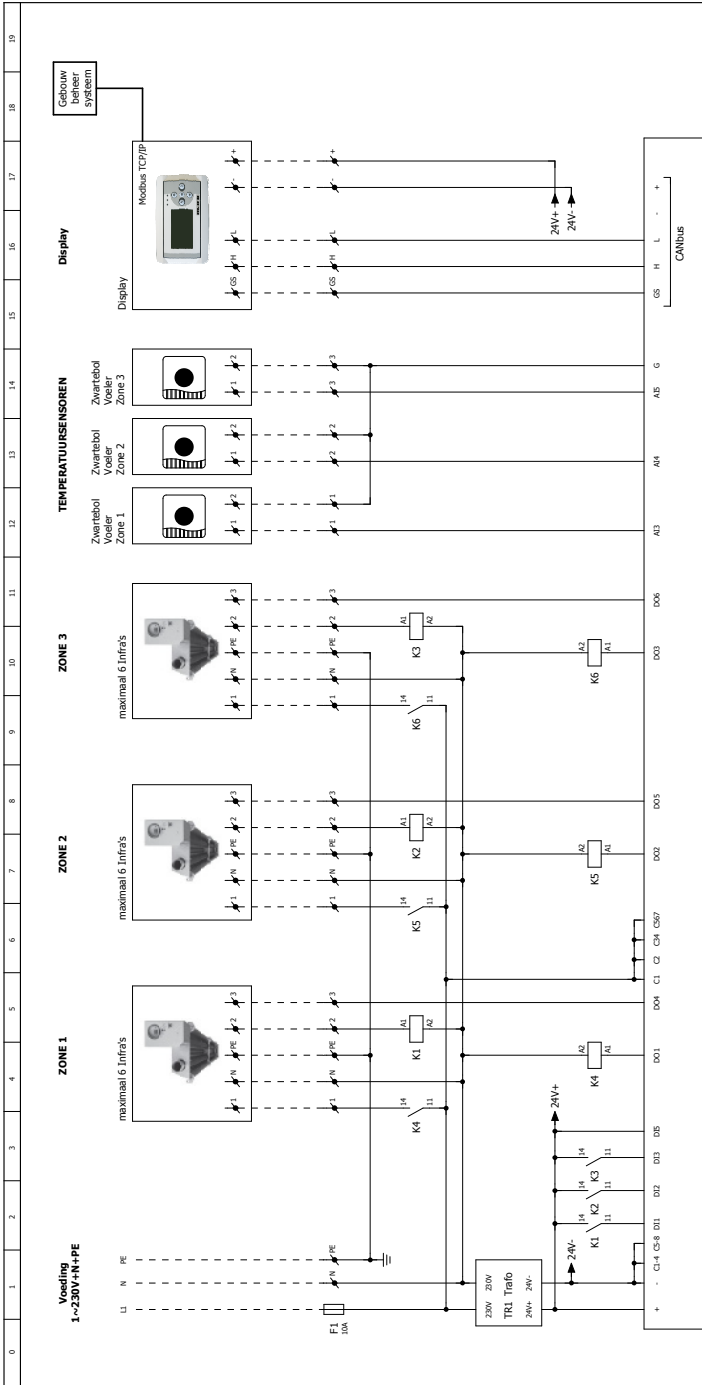

<p><b>Maximaal 6 Infra's aansluiten op 1 Zone</b></p> <p>1 - Fase: 230V          2 - Nul          3 - Storing zone 1          4 - Storing zone 2          5 - Storing zone 3          6 - Warmtevraag zone 1          7 - Warmtevraag zone 2          8 - Warmtevraag zone 3</p>	<p><b>Bekabeling temperatuuroppers:</b></p> <p><b>Diameter:</b></p> <ul style="list-style-type: none"> <li>0,8 mm<sup>2</sup> = maximaal 80 meter</li> <li>1,0 mm<sup>2</sup> = maximaal 100 meter</li> <li>1,5 mm<sup>2</sup> = maximaal 150 meter</li> <li>2,5 mm<sup>2</sup> = maximaal 250 meter</li> </ul> <p><b>Let op:</b></p> <p>Gebruik hiervoor een afgeschermde kabel!</p>	<p><b>Plaatsing temperatuuroppers:</b></p> <p>Temperatuuroppers tochtvrij plaatsen, direct aangestraald</p> <p>Afstand 1,5 meter vanaf de vloer.</p> <p>Indien mogelijk 4 tot 5 meter vanaf de INBRA.</p>	<p><b>Relais:</b></p> <ul style="list-style-type: none"> <li>K1 - Storing zone 1</li> <li>K2 - Storing zone 2</li> <li>K3 - Storing zone 3</li> <li>K4 - Warmtevraag zone 1</li> <li>K5 - Warmtevraag zone 2</li> <li>K6 - Warmtevraag zone 3</li> </ul>																																				
<table border="1"> <tr> <td colspan="2">Elektrisch schema</td> <td colspan="2">Schema</td> </tr> <tr> <td>Doc.:</td> <td>TRD</td> <td>Doc.:</td> <td>1-12-2006</td> </tr> <tr> <td>Loc.:</td> <td></td> <td>Plaats:</td> <td></td> </tr> <tr> <td>Obj.:</td> <td></td> <td>Norm:</td> <td></td> </tr> <tr> <td colspan="2">I-AB1500-NL</td> <td>Titel:</td> <td></td> </tr> <tr> <td colspan="2"></td> <td>Bladz.:</td> <td>30.03.202</td> </tr> <tr> <td colspan="2"></td> <td>Bladz.:</td> <td>1-1</td> </tr> <tr> <td colspan="2"></td> <td colspan="2" style="text-align: right;">→</td> </tr> <tr> <td colspan="2"></td> <td colspan="2" style="text-align: right;">10</td> </tr> </table>				Elektrisch schema		Schema		Doc.:	TRD	Doc.:	1-12-2006	Loc.:		Plaats:		Obj.:		Norm:		I-AB1500-NL		Titel:				Bladz.:	30.03.202			Bladz.:	1-1			→				10	
Elektrisch schema		Schema																																					
Doc.:	TRD	Doc.:	1-12-2006																																				
Loc.:		Plaats:																																					
Obj.:		Norm:																																					
I-AB1500-NL		Titel:																																					
		Bladz.:	30.03.202																																				
		Bladz.:	1-1																																				
		→																																					
		10																																					





0 1 2 3 4 5 6 7 8 9 10 11 12 13 14 15 16 17 18 19

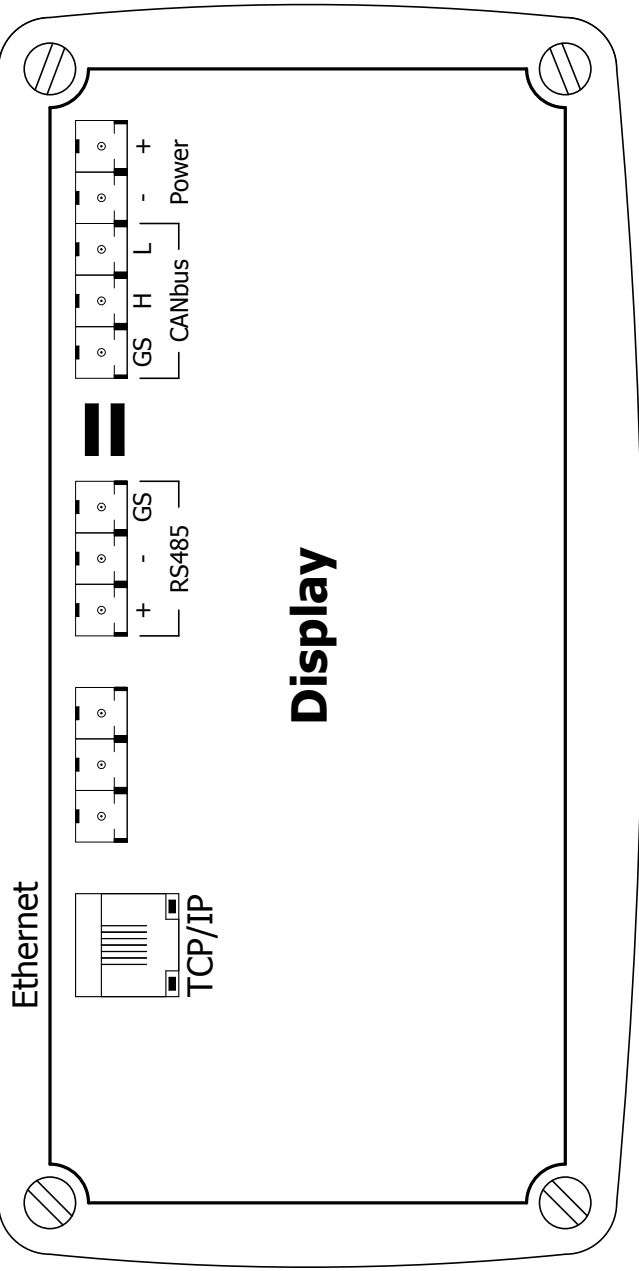
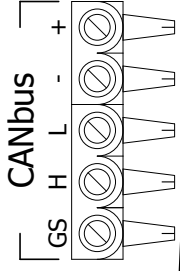

		Infra zone regeling		Aansluit-schema display		Schema nummer		DOC-3003795	
				Get. / Gev.		Datum Norm		Type IAB	
				2-12-2016		Concept		Versie	
				Norm		Act. nr.		1.0	
								100	

## MODBUS TABLE

Modbus TCP/IP	Address 255
---------------	-------------

Description	Modbus Holding registers			Value			
	Zone 1	Zone 2	Zone 3	R/W	min	max	
Operating mode select	16504	16505	16506	R/W	1	4	1=clock 2=constant day 3=constant night 4 = off
Actual temperatuur	9004	9005	9006	R	20	400	value /10
Setpoint day	16507	16508	16509	R/W	20	400	value *10
Setpoint night	16510	16511	16512	R/W	20	400	value *10
Overtime minutes	9007	9008	9009	R/W	0	180	
Overtime on/off	9010	9011	9012	R	0	1	
Burner on	9013	9014	9015	R	0	1	
Error	9016	9017	9018	R	0	1	
Actual setpoint	9019	9020	9021	R	20	400	value /10
Actual operating mode	9022	9023	9024	R	0	4	0=night 1=day 2=off 3=constant night 4=constant day

Description	Modbus			Value			
	Zone 1	Zone 2	Zone 3	R/W	min	max	
Clock block 1 Monday	16552	16629	16706	R/W	0	1	
Clock block 1 Tuesday	16553	16630	16707	R/W	0	1	
Clock block 1 Wednesday	16554	16631	16708	R/W	0	1	
Clock block 1 Thursday	16555	16632	16709	R/W	0	1	
Clock block 1 Friday	16556	16633	16710	R/W	0	1	
Clock block 1 Saturday	16557	16634	16711	R/W	0	1	
Clock block 1 Sunday	16558	16635	16712	R/W	0	1	
Clock block 1 start hour	16559	16636	16713	R/W	0	23	
Clock block 1 start minutes	16560	16637	16714	R/W	0	59	
Clock block 1 stop hour	16561	16638	16715	R/W	0	23	
Clock block 1 stop minutes	16562	16639	16716	R/W	0	59	
Clock block 2 Monday	16563	16640	16717	R/W	0	1	
Clock block 2 Tuesday	16564	16641	16718	R/W	0	1	
Clock block 2 Wednesday	16565	16642	16719	R/W	0	1	
Clock block 2 Thursday	16566	16643	16720	R/W	0	1	
Clock block 2 Friday	16567	16644	16721	R/W	0	1	
Clock block 2 Saturday	16568	16645	16722	R/W	0	1	
Clock block 2 Sunday	16569	16646	16723	R/W	0	1	
Clock block 2 start hour	16570	16647	16724	R/W	0	23	
Clock block 2 start minutes	16571	16648	16725	R/W	0	59	
Clock block 2 stop hour	16572	16649	16726	R/W	0	23	
Clock block 2 stop minutes	16573	16650	16727	R/W	0	59	
Clock block 3 Monday	16574	16651	16728	R/W	0	1	
Clock block 3 Tuesday	16575	16652	16729	R/W	0	1	
Clock block 3 Wednesday	16576	16653	16730	R/W	0	1	
Clock block 3 Thursday	16577	16654	16731	R/W	0	1	
Clock block 3 Friday	16578	16655	16732	R/W	0	1	
Clock block 3 Saturday	16579	16656	16733	R/W	0	1	
Clock block 3 Sunday	16580	16657	16734	R/W	0	1	
Clock block 3 start hour	16581	16658	16735	R/W	0	23	
Clock block 3 start minutes	16582	16659	16736	R/W	0	59	
Clock block 3 stop hour	16583	16660	16737	R/W	0	23	
Clock block 3 stop minutes	16584	16661	16738	R/W	0	59	

Clock block 4 Monday	16585	16662	16739	R/W	0	1	
Clock block 4 Tuesday	16586	16663	16740	R/W	0	1	
Clock block 4 Wednesday	16587	16664	16741	R/W	0	1	
Clock block 4 Thursday	16588	16665	16742	R/W	0	1	
Clock block 4 Friday	16589	16666	16743	R/W	0	1	
Clock block 4 Saturday	16590	16667	16744	R/W	0	1	
Clock block 4 Sunday	16591	16668	16745	R/W	0	1	
Clock block 4 start hour	16592	16669	16746	R/W	0	23	
Clock block 4 start minutes	16593	16670	16747	R/W	0	59	
Clock block 4 stop hour	16594	16671	16748	R/W	0	23	
Clock block 4 stop minutes	16595	16672	16749	R/W	0	59	
Clock block 5 Monday	16596	16673	16750	R/W	0	1	
Clock block 5 Tuesday	16597	16674	16751	R/W	0	1	
Clock block 5 Wednesday	16598	16675	16752	R/W	0	1	
Clock block 5 Thursday	16599	16676	16753	R/W	0	1	
Clock block 5 Friday	16600	16677	16754	R/W	0	1	
Clock block 5 Saturday	16601	16678	16755	R/W	0	1	
Clock block 5 Sunday	16602	16679	16756	R/W	0	1	
Clock block 5 start hour	16603	16680	16757	R/W	0	23	
Clock block 5 start minutes	16604	16681	16758	R/W	0	59	
Clock block 5 stop hour	16605	16682	16759	R/W	0	23	
Clock block 5 stop minutes	16606	16683	16760	R/W	0	59	
Clock block 6Monday	16607	16684	16761	R/W	0	1	
Clock block 6 Tuesday	16608	16685	16762	R/W	0	1	
Clock block 6 Wednesday	16609	16686	16763	R/W	0	1	
Clock block 6 Thursday	16610	16687	16764	R/W	0	1	
Clock block 6 Friday	16611	16688	16765	R/W	0	1	
Clock block 6 Saturday	16612	16689	16766	R/W	0	1	
Clock block 6 Sunday	16613	16690	16767	R/W	0	1	
Clock block 6 start hour	16614	16691	16768	R/W	0	23	
Clock block 6 start minutes	16615	16692	16769	R/W	0	59	
Clock block 6 stop hour	16616	16693	16770	R/W	0	23	
Clock block 6 stop minutes	16617	16694	16771	R/W	0	59	
Clock block 7 Monday	16618	16695	16772	R/W	0	1	
Clock block 7 Tuesday	16619	16696	16773	R/W	0	1	
Clock block 7 Wednesday	16620	16697	16774	R/W	0	1	
Clock block 7 Thursday	16621	16698	16775	R/W	0	1	
Clock block 7 Friday	16622	16699	16776	R/W	0	1	
Clock block 7 Saturday	16623	16700	16777	R/W	0	1	
Clock block 7 Sunday	16624	16701	16778	R/W	0	1	
Clock block 7 start hour	16625	16702	16779	R/W	0	23	
Clock block 7 start minutes	16626	16703	16780	R/W	0	59	
Clock block 7 stop hour	16627	16704	16781	R/W	0	23	
Clock block 7 stop minutes	16628	16705	16782	R/W	0	59	



**MARK BV**

BENEDEN VERLAAT 87-89  
VEENDAM (NEDERLAND)  
POSTBUS 13, 9640 AA VEENDAM  
TELEFOON +31 (0)598 656600  
FAX +31 (0)598 624584  
info@mark.nl  
www.mark.nl

**MARK EIRE BV**

COOLEA, MACROOM  
CO. CORK  
P12 W660 (IRELAND)  
PHONE +353 (0)26 45334  
FAX +353 (0)26 45383  
sales@markeire.com  
www.markeire.com

**MARK BELGIUM b.v.b.a.**

ENERGIELAAN 12  
2950 KAPellen  
(BELGIË/BELGIQUE)  
TELEFOON +32 (0)3 6669254  
info@markbelgium.be  
www.markbelgium.be

**MARK DEUTSCHLAND GmbH**

MAX-PLANCK-STRASSE 16  
46446 EMMERICH AM RHEIN  
(DEUTSCHLAND)  
TELEFON +49 (0)2822 97728-0  
TELEFAX +49 (0)2822 97728-10  
info@mark.de  
www.mark.de

**MARK POLSKA Sp. z o.o**

UL. JASNOGÓRSKA 27  
42-202 CZĘSTOCHOWA (POLSKA)  
PHONE +48 34 3683443  
FAX +48 34 3683553  
info@markpolska.pl  
www.markpolska.pl

**MARK SRL ROMANIA**

STR. BANEASA NO 8 (VIA STR. LIBERTATII)  
540199 TÂRGU-MURES, JUD MURES  
(ROMANIA)  
TEL/FAX +40 (0)265-266.332  
office@markromania.ro  
www.markromania.ro

