

# TOSHIBA

## AIR CONDITIONER (SPLIT TYPE) Installation Manual

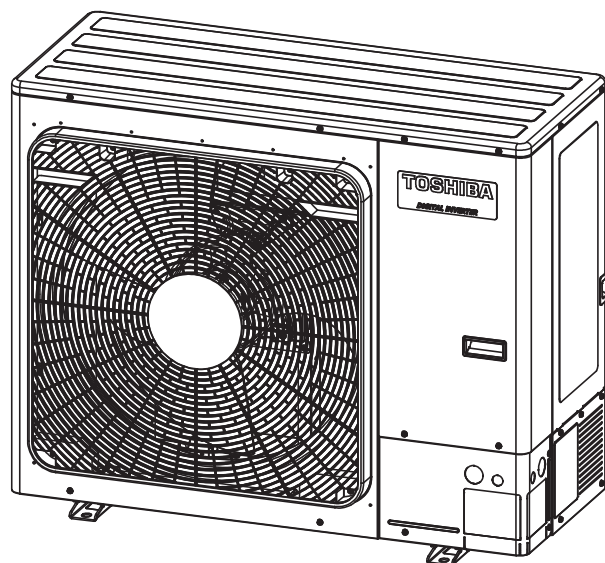

### Outdoor Unit

Model name:

For commercial use

**RAV-GM2243AT8P-E**  
**RAV-GM2243AT8JP-E**  
**RAV-GM2803AT8P-E**  
**RAV-GM2803AT8JP-E**

Scan QR CODE to access installation and owner's manual on website.

<https://www.toshiba-carrier.co.th/manuals/default.aspx>

Manual are available in EN/FR/DE/IT/ES/PT/NL/EL/RU/TR/SV/FI/DA/  
NO/PL/BG/RO/ET/LV/HR/SK/SL/HU/CS/AR.



**Original instruction**

Please read this Installation Manual carefully before installing the Air Conditioner.

- This Manual describes the installation method of the outdoor unit.
- For installation of the indoor unit, follow the Installation Manual attached to the indoor unit.

**ADOPTION OF R32 REFRIGERANT**

This air conditioner adopts the HFC refrigerant (R32) which does not destroy the ozone layer.  
 This outdoor unit is designed exclusively for use with R32 refrigerant. Be sure to use in combination with a R32 refrigerant indoor unit.

**Regulation of harmonic current**

This equipment complies with IEC 61000-3-12 provided that the short-circuit power  $S_{sc}$  is greater than or equal to  $S_{sc} (*1)$  at the interface point between the user's supply and the public system. It is the responsibility of the installer or user of the equipment to ensure, by consultation with the distribution network operator if necessary, that the equipment is connected only to a supply with a short-circuit power  $S_{sc}$  greater than or equal to  $S_{sc} (*1)$ .

$S_{sc} (*1)$

Model	$S_{sc}$ (MVA)
RAV-GM2243AT8(J)P-E	1.33
RAV-GM2803AT8(J)P-E	1.41

This unit complies with EN 61000-3-11.  
 However, the impedance of the power supply system to be connected to the unit at the incoming power point must be less than the  $Z_{max}$  given below.  
 In order to meet this condition, consult with the supply authority as required.

**$Z_{max} = 0.65 (\Omega)$**

In addition, it is recommended that voltage drops occurring during the unit's operation in the area at the power input shall be around 3.3% of the nominal power-supply voltage or less.

**Contents**

**1 Accessory parts . . . . . 3**

**2 Installation of R32 refrigerant air conditioner . . . . . 3**

**3 Installation conditions . . . . . 4**

**4 Refrigerant piping . . . . . 7**

**5 Air purging . . . . . 10**

**6 Electrical work . . . . . 13**

**7 Earthing . . . . . 15**

**8 Finishing . . . . . 15**

**9 Test run . . . . . 15**

**10 Annual maintenance . . . . . 15**

**11 Air conditioner operating conditions . . . . . 16**

**12 Functions to be implemented locally . . . . . 16**

**13 Troubleshooting . . . . . 18**

**14 Appendix . . . . . 19**

**15 Specifications . . . . . 21**

**16 Installation check list . . . . . 24**

## ■ Center of gravity

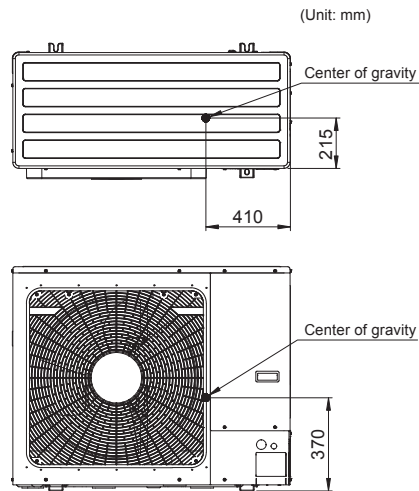

## ⚠ CAUTION

### Cautions for outdoor unit installation space

- In the event that the outdoor unit is installed in a small space and refrigerant leaks, accumulation of highly concentrated refrigerant may cause a fire hazard. Therefore, be sure to follow the installation space instructions in the Installation Manual, and provide open space on at least one of the four outdoor unit sides.
- In particular, when both the discharge and intake sides face walls and obstacles are also placed on both sides of the outdoor unit, take steps to provide space wide enough for a person to pass (600 mm or more) on one side to prevent leaked refrigerant from accumulating.

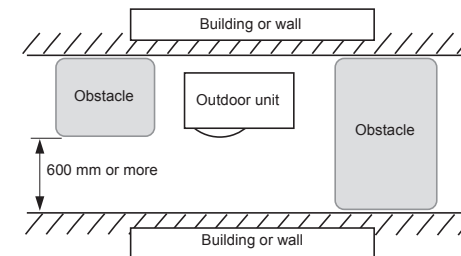









### To disconnect the appliance from main power supply

- This appliance must be connected to the main power supply by means of a switch with a contact separation of at least 3 mm.

### Do not wash air conditioners with pressure washers

- Electric leaks may cause electric shocks or fires.

# 1 Accessory parts

Part name	Q'ty	Shape	Usage
Installation Manual	1	Booklet	For hand this directly to the customer.
Joint (Ø19.1 – Ø28.6 mm)	1		For connecting the pipe
Joint (Ø28.6 – Ø28.6 mm)	1		For connecting the pipe
Drain nipple	1		
Waterproof rubber cap	5		
Protective bush	1		For protecting wires (pipe cover)
Guard material for passage part	1		For protecting passage part (pipe cover)
Rub-Sheet	1		For protecting small lizard.
Safety Manual	1		For hand over directly to the customer.

## INFORMATION

- The main pipe on the gas side of this outdoor unit has a diameter of Ø28.6 mm, but a Ø19.1 mm flare connection is used where the valve is connected. Be sure to use the Ø19.1 mm pipe and joint provided as accessories for the pipe connection.
- Before installing the unit, check that the unit has the correct model name to prevent the wrong unit from being installed in the wrong place.
- Before proceeding to weld the refrigerant pipe, be sure to pass nitrogen through the pipe.
- Before installing the indoor units, read the instructions in the installation manual provided with the indoor units.
- Before installing a branch pipe, read the instructions in the installation manual provided with the branch pipe kit.
- In the case of a simultaneous double twin system, use indoor unit with the same capacity for all four indoor units.

	Branch pipe kit	Combination indoor unit
RAV-GM2243	RBC-DTWP101E	RM56 × 4 units
RAV-GM2803	RBC-DTWP101E	RM80 × 4 units

- P.C. Board settings are required for some of the indoor units if they are to be used in a twin, triple or double twin system. Refer to the instructions in the installation manual of the branch pipe kit, and ensure that the settings are selected correctly.
- Combination with the indoor units.  
Combination with the indoor units is possible only when units with the same type are combined.  
Combinations of units with different types cannot be used.
- The concealed duct high static pressure type is used for a single connection (when connecting a single indoor unit to the outdoor unit).

# 2 Installation of R32 refrigerant air conditioner

## ⚠ CAUTION

### R32 refrigerant air conditioner installation

- This air conditioner adopts the HFC refrigerant (R32) which does not destroy ozone layer.**

Therefore, during installation work, make sure that water, dust, former refrigerant, or refrigerant oil does not enter the R32 refrigerant air conditioner cycle. To prevent mixing of refrigerant or refrigerant oil, the sizes of connecting sections of charge port on the main unit and installation tools are different from those of the conventional refrigerant units.

Accordingly, special tools are required for the R32 or R410A refrigerant units. For connecting pipes, use new and clean piping materials with high pressure fittings made for the R32 or R410A only, so that water and/or dust does not enter.

- When using existing piping, refer to “14. Appendix - [1] Existing piping”.

## ■ Required tools / equipment and precautions for use

Prepare the tools and equipment listed in the following table before starting the installation work. Newly prepared tools and equipment must be used exclusively.

### Legend

△: Conventional tools (R32 or R410A)

⊙: Prepared newly (Use for R32 only)

Tools / equipment	Use	How to use tools / equipment
Gauge manifold	Vacuumping / charging refrigerant and operation check	△ Conventional tools (R410A)
Charging hose		△ Conventional tools (R410A)
Charging cylinder	Cannot be used	Unusable (Use the electronic refrigerant charging scale)
Gas leak detector	Charging refrigerant	△ Conventional tools (R32 or R410A)
Vacuum pump	Vacuum drying	△ Conventional tools (R32 or R410A) Usable if the backflow prevention adapter is installed.
Vacuum pump with backflow prevention function	Vacuum drying	△ Conventional tools (R32 or R410A)
Flare tool	Flare machining of pipes	△ Conventional tools (R410A)
Bender	Bending pipes	△ Conventional tools (R410A)
Refrigerant recovery equipment	Refrigerant recovery	△ Conventional tools (R32 or R410A)
Torque wrench	Tightening flare nuts	△ Conventional tools (R410A)
Pipe cutter	Cutting pipes	△ Conventional tools (R410A)
Refrigerant cylinder	Charging refrigerant	⊙ Prepared newly (Use for R32 only)
Welding machine and nitrogen cylinder	Welding pipes	△ Conventional tools (R410A)
Electronic refrigerant charging scale	Charging refrigerant	△ Conventional tools (R32 or R410A)

## ■ Refrigerant piping

### R32 refrigerant

#### CAUTION

- Incomplete flaring may cause refrigerant gas leakage.
- Do not re-use flares. Use new flares to prevent refrigerant gas leakage.
- Use flare nuts that are included with the unit. Using different flare nuts may cause refrigerant gas leakage.

Use the following item for the refrigerant piping.

Material : Seamless phosphorous deoxidized copper pipe.

Ø6.35, Ø9.52, Ø12.7 Wall thickness 0.8 mm or more

Ø15.88 Wall thickness 1.0 mm or more

Ø19.1 Wall thickness 1.2 mm or more

Ø28.6 (half hard) Wall thickness 1.0 mm or more

#### REQUIREMENT

- When the refrigerant pipe is long, provide support brackets at intervals of 2.5 to 3 m to clamp the refrigerant pipe.
- Otherwise, abnormal sound may be generated.

## 3 Installation conditions

### ■ Before installation

Be sure to prepare to the following items before installation.

#### Length of refrigerant pipe

Length of refrigerant pipe connected to indoor/outdoor unit	Height difference (Indoor-outdoor)		Item
	Indoor unit: Upper	Outdoor unit: Lower	
5 to 100 m	30 m	30 m	Addition of refrigerant at the local site is unnecessary for refrigerant pipe lengths up to 30 m. If the refrigerant pipe length exceeds 30 m, add refrigerant in the amount given in "Charging additional refrigerant".

- \* Caution during addition of refrigerant. Charge the refrigerant accurately. Overcharging may cause serious trouble with the compressor.
- Do not connect a refrigerant pipe that is shorter than **5 m**. This may cause a malfunction of the compressor or other devices.

#### Airtight test

1. Before starting an airtight test, further tighten the spindle valves on the gas and liquid sides.
2. Pressurize the pipe with nitrogen gas charged from the service port to the design pressure (4.15 MPa) to conduct an airtight test.
3. After the airtight test is completed, evacuate the nitrogen gas.

#### Air purge

- To purge air, use a vacuum pump.
- Do not use refrigerant charged in the outdoor unit to purge air. (The air purge refrigerant is not contained in the outdoor unit.)

### Electrical wiring

- Be sure to fix the power wires and indoor/outdoor connecting wires with clamps so that they do not come into contact with the cabinet, etc.

### Earthing

#### WARNING

**Make sure that proper earthing is provided.** Improper earthing may cause an electric shock. For details on how to check earthing, contact the dealer who installed the air conditioner or a professional installation company.

- Proper earthing can prevent charging of electricity on the outdoor unit surface due to the presence of a high frequency in the frequency converter (inverter) of the outdoor unit, as well as prevent electric shock. If the outdoor unit is not properly earthed, you may be exposed to an electric shock.
- **Be sure to connect the earth wire. (grounding work)** Incomplete earthing can cause an electric shock. Do not connect earth wires to gas pipes, water pipes, lightning rods or earth wires for telephone wires.

### Test run

Turn on the leakage breaker at least 12 hours before starting a test run to protect the compressor during startup.

#### CAUTION

Incorrect installation work may result in a malfunction or complaints from customers.

## ■ Installation location

### ⚠ WARNING

**Install the outdoor unit properly in a location that is durable enough to support the weight of the outdoor unit.**

Insufficient durability may cause the outdoor unit to fall, which may result in injury. This outdoor unit has a weight of about 117 kg. Pay special attention when installing the unit onto a wall surface.

### ⚠ CAUTION

**Do not install the outdoor unit in a location that is subject to combustible gas leaks.**

Accumulation of combustible gas around the outdoor unit may cause a fire.

**Install the outdoor unit in a location that meets the following conditions after the customer's consent is obtained.**

- A well-ventilated location free from obstacles near the air intakes and air discharge.
- A location that is not exposed to rain or direct sunlight.
- A location that does not increase the operating noise or vibration of the outdoor unit.
- A location that does not produce any drainage problems from discharged water.

**Do not install the outdoor unit in the following locations.**

- A location with a saline atmosphere (coastal area) or one that is full of sulfide gas (hot-spring area) (Special maintenance is required).
- A location subject to oil, vapor, oily smoke, or corrosive gases.
- A location in which organic solvent is used.
- Places where iron or other metal dust is present. If iron or other metal dust adheres to or collects on the interior of the air conditioner, it may spontaneously combust and start a fire.
- A location where high-frequency equipment (including inverter equipment, private power generator, medical equipment, and communication equipment) is used (Installation in such a location may cause malfunction of the air conditioner, abnormal control or problems due to noise from such equipment).
- A location in which the discharged air of the outdoor unit blows against the window of a neighboring house.
- A location where the operating noise of the outdoor unit is transmitted.
- When the outdoor unit is installed in an elevated position, be sure to secure its feet.
- A location in which drain water poses any problems.

### ⚠ CAUTION

- 1 Install the outdoor unit in a location where the discharge air is not blocked.**
- 2 When an outdoor unit is installed in a location that is always exposed to strong winds like a coast or on the high stories of a building, secure normal fan operation by using a duct or wind shield.**
- 3 When installing the outdoor unit in a location that is constantly exposed to strong winds such as on the upper stairs or rooftop of a building, apply the wind-proofing measures referred to in the following examples.**

1. Install the unit so that its discharge port faces the wall of the building. Keep a distance 500 mm or more between the unit and wall surface.

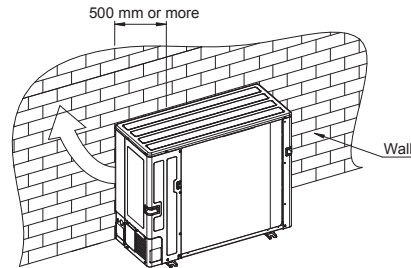

2. Consider the wind direction during the operational season of the air conditioner, and install the unit so that the discharge port is set at a right angle relative to the wind direction.

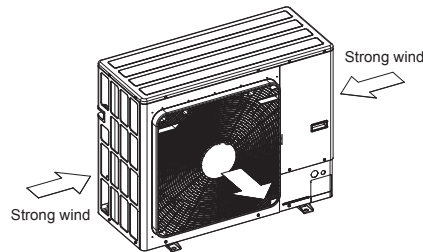

3. When installing the unit in an area where snowfalls may be heavy, take steps to prevent the unit from being adversely affected by the fallen or accumulated snow.
  - Either make the foundation higher or install a stand (which is high enough to ensure that the unit will be above the fallen or accumulated snow) and place the unit on it.
  - Attach a snow shield (locally procured).

<Example>

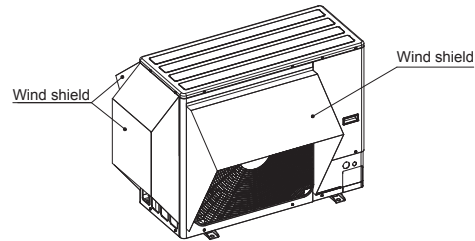

## ■ Necessary space for installation (Unit: mm)

### Obstacle at rear side

#### Upper side is free

1. Single unit installation

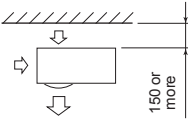

2. Obstacles on both right and left sides

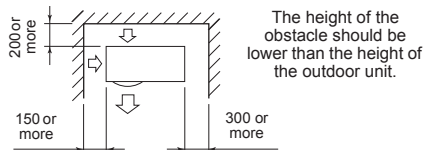

3. Serial installation of two or more units

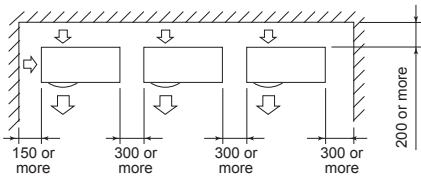

The height of the obstacle should be lower than the height of the outdoor unit.

#### Obstacle also above unit

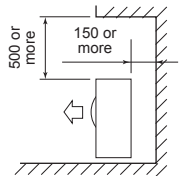

### Obstacle in front

#### Above unit is free

1. Single unit installation

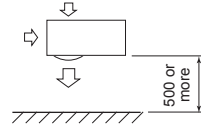

2. Serial installation of two or more units

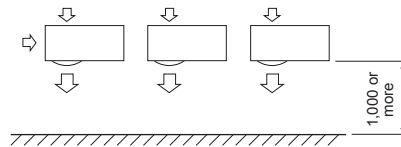

#### Obstacle also at the above unit

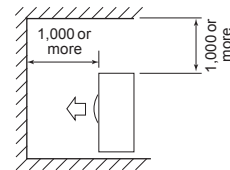

### Obstacles in both front and rear of unit

Open above and to the right and left of the unit.

The height of an obstacle in both the front and rear of the unit, should be lower than the height of the outdoor unit.

#### Standard installation

1. Single unit installation

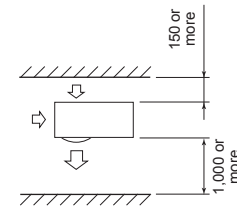

2. Serial installation of two or more units

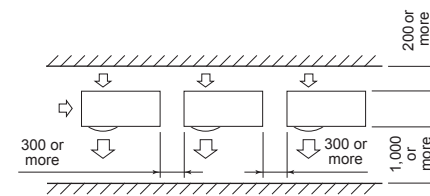

### Serial installation in front and rear

Open above and to the right and left of the unit.

The height of an obstacle in both the front and rear of the unit, should be lower than the height of the outdoor unit.

#### Standard installation

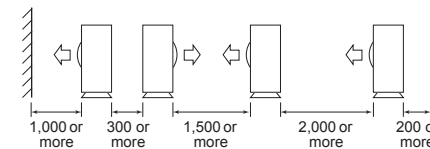

## ■ Installation of outdoor unit

- Before installation, check the strength and horizontalness of the base so that abnormal sounds do not emanate.
- According to the following base diagram, fix the base firmly with the anchor bolts.  
(Anchor bolt, nut: M10 x 4 pairs)

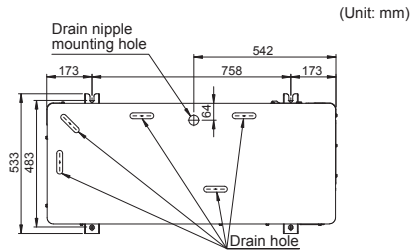

- As shown in the figure below, install the foundation and vibration-proof rubber pads to directly support the bottom surface of the fixing leg that is in contact with and underneath the bottom plate of the outdoor unit.
- \* When installing the foundation for an outdoor unit with downward piping, consider the piping work.

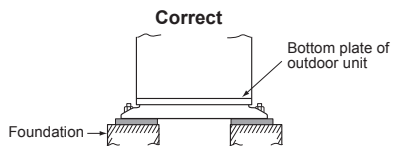
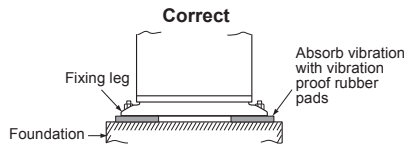

Support the bottom surface of the fixing leg that is in contact with and underneath the bottom plate of the outdoor unit.

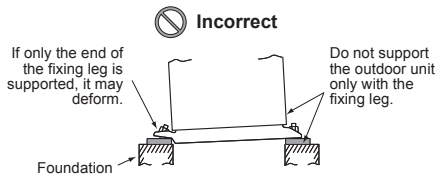

Set the out margin of the anchor bolt to 15 mm or less.

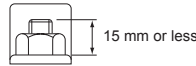

- When water is to be drained through the drain hose, attach the following drain nipple and waterproof rubber cap, and use the drain hose (Inner dia.: 16 mm) sold on the market. Also seal knockout hole and the screws securely with silicone material, etc., to prevent water from leaking. Some conditions may cause dewing or dripping of water.
- When collectively draining discharged water completely, use a drain pan.

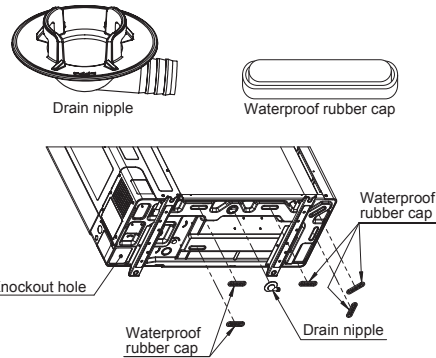

## ■ For reference

If a heating operation is to be continuously performed for a long time under the condition that the outdoor temperature is 0°C or lower, draining defrosted water may be difficult due to the bottom plate freezing, resulting in trouble with the cabinet or fan. It is recommended to procure an anti-freeze heater locally in order to safely install the air conditioner. For details, contact the dealer.

## ⚠ WARNING

- **Be sure to install the outdoor unit in a place able to bear its weight.**  
If strength is insufficient, the unit may fall down resulting in human injury.
- **Perform specified installation work to protect against strong wind and earthquakes.**  
If the outdoor unit is imperfectly installed, an accident by falling or dropping may be caused.

# 4 Refrigerant piping

## ■ Refrigerant piping

1. Use the following items for the refrigerant piping.

- Material : Seamless phosphorous deoxidized copper pipe.
- Ø12.7 Wall thickness 0.8 mm or more
- Ø28.6 (half hard) Wall thickness 1.0 mm or more.
- Do not use any copper pipes with a wall thickness less than these thicknesses.

## Removing service panel

- Remove the screws at 3 locations and slide the service panel down. Next, detach the right-side claws followed by left-side claws to remove the service panel. When doing this, pulling the service panel towards the front could damage the claws. When attaching the service panel, attach the left claws followed by the right claws and lift the service panel upwards and secure it with screws in the 3 locations.

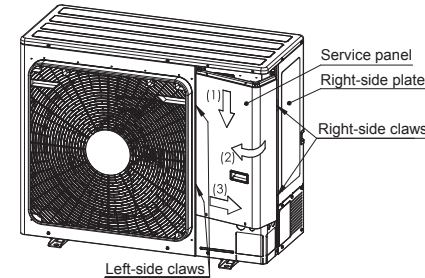

## ■ Knockout of pipe cover

### Knockout procedure

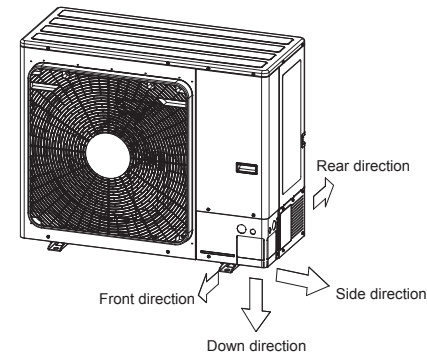

- The indoor / outdoor connecting pipes can be connected in 4 directions. Take off the knockout part of the pipe cover through which pipes or wires will pass through the base plate.
- Detach the pipe cover and tap on the knockout section a few times with the shank of a screwdriver. A knockout hole can easily be punched.
- After punching out the knockout hole, remove burrs from the hole and then install the supplied protective bush and guard material around the passage hole to protect wires and pipes. Be sure to attach the pipe covers after pipes have been connected. Cut the slits under the pipe covers to facilitate the installation. After connecting the pipes, be sure to mount the pipe cover. The pipe cover is easily mounted by cutting off the slit at the lower part of the pipe cover.

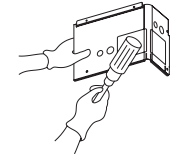

- \* Be sure to wear heavy work gloves while working.

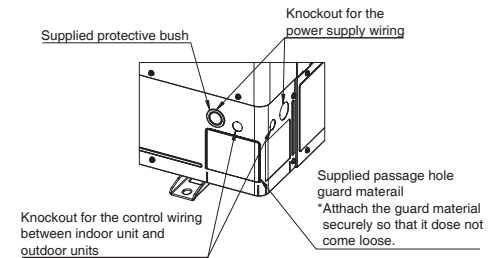

Sticking RUBBER SHEET after finish connecting of PIPE-CONNECT follow as the picture.

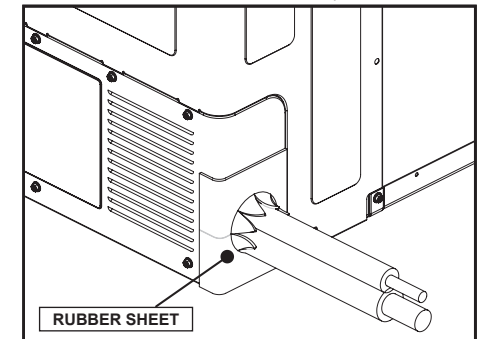



## Optional installation parts (Locally procured)

	Parts name	Q'ty
A	Refrigerant piping Liquid side: Ø12.7 mm Gas side: Ø28.6 mm	One each
B	Socket: Ø28.6 - Ø28.6 mm	1
C	Pipe insulating material (polyethylene foam, 10 mm thick)	1
D	Putty, PVC tape	One each

## Refrigerant piping connection

### CAUTION

Take note of these 4 important points below for piping work.

1. Keep dust and moisture away from inside the connecting pipes.
2. Tightly connect the connection between pipes and the unit.
3. Evacuate the air in the connecting pipes using a VACUUM PUMP.
4. Check for gas leaks at connection points.

### Piping connection

Liquid side	
Outer diameter	Thickness
Ø12.7 mm	0.8 mm

Gas side	
Outer diameter	Thickness
Ø28.6 mm	1.0 mm (half hard)

## Flaring

1. Cut the pipe with a pipe cutter.  
Be sure to remove burrs that may cause a gas leak.
2. Insert a flare nut into the pipe, and then flare the pipe.  
Use the flare nuts supplied with the air conditioner or those for R32.  
Insert a flare nut into the pipe, and flare the pipe.  
Use the flare nuts supplied with the air conditioner or flare nuts for R32 or R410A.  
However, the conventional tools can be used by adjusting the projection margin of the copper pipe.

Projection margin in flaring: B (Unit: mm)

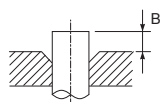

RIDGID (Clutch type)

Outer dia. of copper pipe	R32 or R410A tool used	Conventional tool used
12.7	0 to 0.5	1.0 to 1.5
19.1		

Flaring dia. size: A (Unit: mm)

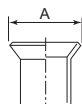

Outer dia. of copper pipe	A
12.7	+0 -0.4
19.1	16.6
	24.0

### CAUTION

- Do not scratch the inner surface of the flared part when removing burrs.
- Flare processing under the condition of scratches on the inner surface of flare processing part will cause refrigerant gas leak.
- Check that the flared part is not scratched, deformed, stepped, or flattened, and that there are no chips adhered or other problems, after flare processing.
- Do not apply refrigerating machine oil to the flare surface.

## Connecting the Gas Side Pipe

### REQUIREMENT

- Be sure to use the Ø19.1 mm pipe and joint provided as accessories of the outdoor unit to connect the gas side Ø19.1 mm pipe and Ø28.6 mm pipe.
- When leading out the pipes toward the front, to one of the sides or toward the rear, use the Ø19.1 mm pipe and elbow provided as accessories of the outdoor unit, and adjust the bending direction.  
Cut the Ø19.1 mm pipe to the required length before using it.

1. Align the provided Ø19.1 mm pipe with the pipe lead-out direction, and shape it so that its end comes out from the outdoor unit.
2. On the outside of the outdoor unit, use the provided joints, and braze the Ø19.1 mm pipe and Ø28.6 mm pipe.

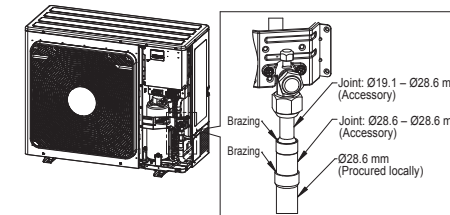

### CAUTION

Wrap the valves at the gas and the liquid side in wet cloth to keep it cool and prevent the heat from the torch from damaging it when connecting the pipe to the valve on the gas and the liquid line.

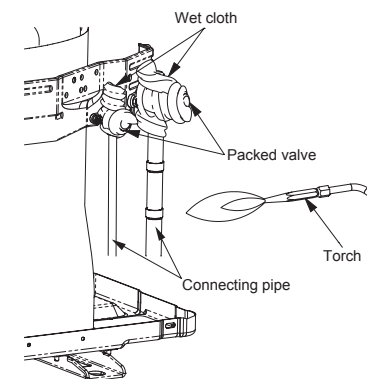

### REQUIREMENT

- Before proceeding to brazing the refrigerant pipe, be sure to pass nitrogen through the pipe to prevent oxidation inside it. If nitrogen is not passed through the pipe, the refrigerating cycle may become clogged by oxidized scales.

2. As shown in the figure, be sure to use two wrenches to loosen or tighten the flare nut of the valve on the gas side. If you use a single crescent, the flare nut cannot be tightened to the required tightening torque.

On the other hand, use a single crescent to loosen or tighten the flare nut of the valve on the liquid side.

(Unit: N·m)

Outer dia. of copper pipe	Tightening torque
12.7 mm (diam.)	50 to 62
19.1 mm (diam.)	100 to 120

## Tightening of connecting part

1. Align the centers of the connecting pipes and fully tighten the flare nut with your fingers. Then fix the nut with a wrench as shown in the figure and tighten it with a torque wrench.

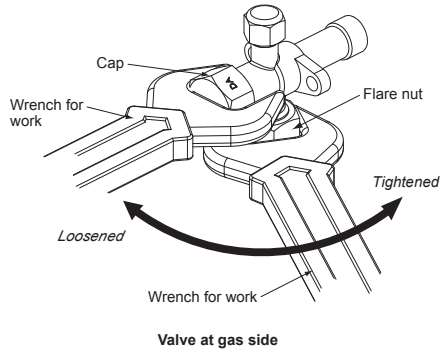

### Branch Pipe

Carry out the refrigerant piping work using the branch pipe kit which is purchased separately.  
Branching pipe model name RBC-TWP101E, RBC-TRP100E, RBC-DTWP101E

#### Branch pipe installation

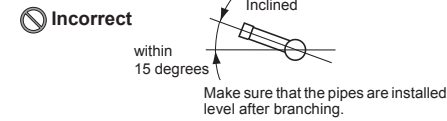
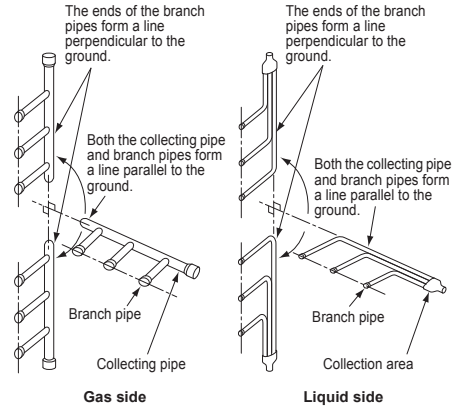

#### Length of straight sections on main pipe side of branch pipe

Provide a straight section with a length of at least 500 mm on the main pipe side of the branch pipe. (Same for both liquid side and gas side)

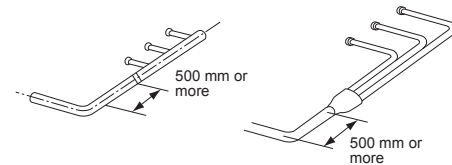

#### CAUTION

- Do not put the crescent wrench on the cap or cover. The valve may break.
- If applying excessive torque, the nut may break according to some installation conditions.

#### Incorrect

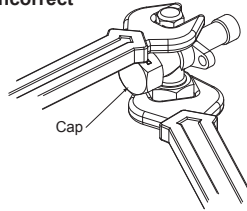

- After the installation work, be sure to check for gas leaks of the pipe connections with nitrogen.
- Therefore, using a torque wrench, tighten the flare pipe connecting sections that connect the indoor/outdoor units at the specified tightening torque. Incomplete connections may cause not only a gas leak, but also trouble with the refrigeration cycle.

Do not apply refrigerant oil to the flared surface.

### Refrigerant pipe length

#### Single

Outdoor unit	Allowable pipe length (m)		Height difference (m)	
	Total length $\ell$		Indoor-outdoor H	
	Minimum	Maximum	Indoor unit: Upper	Outdoor unit: Upper
GM2243	5	100	30	30
GM2803	5	100	30	30

Outdoor unit	Pipe diameter (mm)		Number of bent portions
	Gas side	Liquid side	
GM2243	Ø28.6	Ø12.7	10 or less
GM2803	Ø28.6	Ø12.7	10 or less

Figure of Single

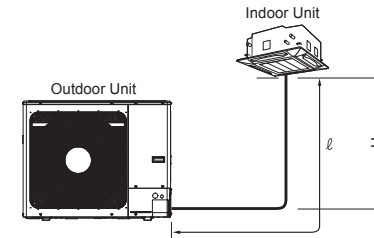

#### Simultaneous twin, triple

Outdoor unit	Allowable pipe length (m)			Height difference (m)		
	Total length • $\ell_1 + \ell_2$ • $\ell_1 + \ell_3$ • $\ell_1 + \ell_4$ Maximum	Branch piping • $\ell_2$ • $\ell_3$ • $\ell_4$ Maximum	Branch piping • $\ell_3 + \ell_2$ • $\ell_4 + \ell_2$ • $\ell_4 + \ell_3$ Maximum	Indoor-outdoor H		
				Indoor unit: Upper	Outdoor unit: Upper	Indoor-indoor ( $\Delta h$ )
GM2243	100	20	10	30	30	0.5
GM2803	100	20	10	30	30	0.5

Outdoor unit	Pipe diameter (mm)				Number of bent portions
	Main pipe		Branch piping		
	Gas side	Liquid side	Gas side	Liquid side	
GM2243	Ø28.6	Ø12.7	Ø15.9	Ø9.5	10 or less
GM2803	Ø28.6	Ø12.7	Ø15.9	Ø9.5	10 or less

Figure of Simultaneous twin

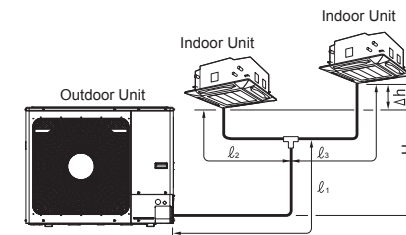
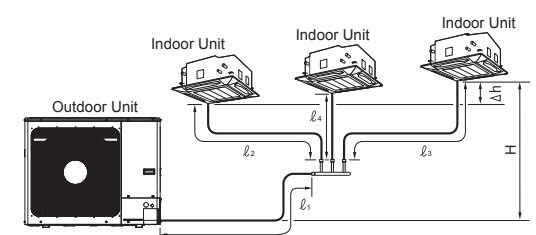

Figure of Simultaneous triple



## Simultaneous double twin

Outdoor unit	Allowable pipe length (m)				Height difference (m)		
	Total length • $l_1 + l_2 + l_4$ • $l_1 + l_2 + l_5$ • $l_1 + l_3 + l_6$ • $l_1 + l_3 + l_7$ Maximum	Branch piping • $l_4$ • $l_5$ • $l_6$ • $l_7$ Maximum	Branch piping • $l_5 + l_2$ • $l_6 + l_3$ • $l_7 + l_3$ Maximum	Branch piping • $(l_4 + l_2) - (l_5 + l_2)$ • $(l_4 + l_2) - (l_6 + l_3)$ • $(l_4 + l_2) - (l_7 + l_3)$ • $(l_5 + l_2) - (l_6 + l_3)$ • $(l_5 + l_2) - (l_7 + l_3)$ • $(l_6 + l_3) - (l_7 + l_3)$ Maximum	Indoor-outdoor H		
					Indoor unit: Upper	Outdoor unit: Upper	Indoor-outdoor ( $\Delta h$ )
GM2243	100	15	20	6	30	30	0.5
GM2803	100	15	20	6	30	30	0.5

Outdoor unit	Pipe diameter (mm)				Number of bent portions
	Main pipe		Branch piping		
	Gas side	Liquid side	Gas side	Liquid side	
GM2243	Ø28.6	Ø12.7	$l_2, l_3$ : Ø15.9 $l_4, l_5, l_6, l_7$ : Ø12.7	$l_2, l_3$ : Ø9.5 $l_4, l_5, l_6, l_7$ : Ø6.4	10 or less
GM2803	Ø28.6	Ø12.7	$l_2$ to $l_7$ : Ø15.9	$l_2$ to $l_7$ : Ø9.5	10 or less

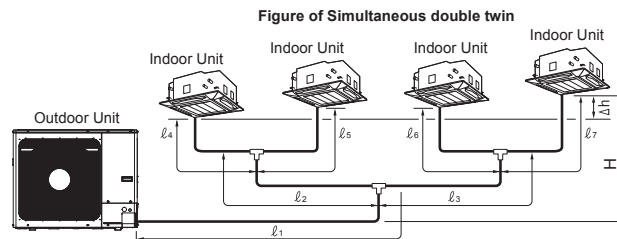

# 5 Air purging

## ■ Airtight Test

After completing the refrigerant piping work, perform an airtight test. Connect a nitrogen gas cylinder and pressurize the pipes with nitrogen gas as follows to conduct the airtight test.

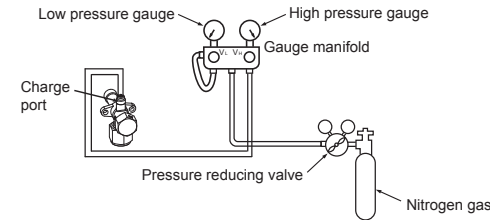

### ⚠ CAUTION

Never use oxygen, flammable gas, or noxious gas for the airtight test.

## Gas leak check

- Step 1....Pressurize to **0.5 MPa** (5 kg/cm<sup>2</sup>G) for 5 minutes or longer.
- Step 2....Pressurize to **1.5 MPa** (15 kg/cm<sup>2</sup>G) for 5 minutes or longer. > Major leaks can be discovered.
- Step 3....Pressurize to **4.15 MPa** (42 kg/cm<sup>2</sup>G) for 24 hours. .... Micro leaks can be discovered.

(However, note that when the ambient temperature differs during pressurization and after 24 hours, the pressure will change by approximately 0.01 MPa (0.1 kg/cm<sup>2</sup>G) per 1°C, so this should be compensated.)

If the pressure drops in steps 1 through 3, check the connections for leakage. Check for leaks with foaming liquid, etc., take steps to fix the leaks such as brazing the pipes again and tightening the flare nuts, and then perform the airtight test again.

\* After the airtight test is completed, evacuate the nitrogen gas.

## ■ Air purge

With respect to the preservation of the terrestrial environment, adopt "Vacuum pump" to purge air (Evacuate air in the connecting pipes) when installing the unit.

- Do not discharge the refrigerant gas to the atmosphere to preserve the terrestrial environment.
- Use a vacuum pump to discharge the air (nitrogen, etc.) that remains in the set. If air remains, the capacity may decrease.

For the vacuum pump, be sure to use one with a backflow preventer so that the oil in the pump does not backflow into the pipe of the air conditioner when the pump stops.

(If oil in the vacuum pump is put in an air conditioner including R32, it may cause trouble with the refrigeration cycle.)

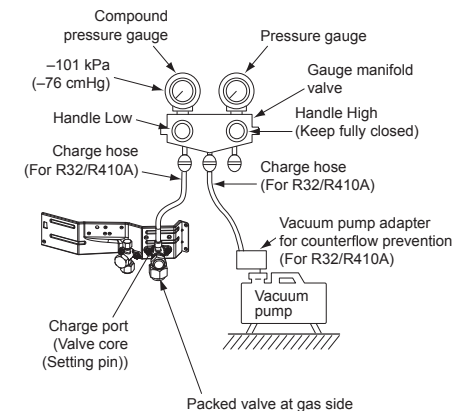

### Vacuum pump

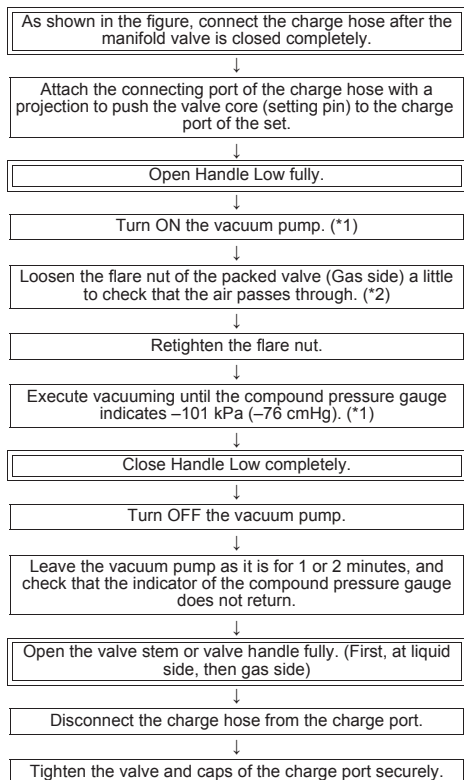

\*1: Use the vacuum pump, vacuum pump adapter, and gauge manifold correctly referring to the manuals supplied with each tool before using them. Check that the vacuum pump oil is filled up to the specified line of the oil gauge.

\*2: When air is not charged, check again whether the connecting port of the discharge hose, which has a projection to push the valve core, is firmly connected to the charge port.

### Pump down process

1. Turn off the Air Conditioner system.
2. Connect the charge hose from the manifold valve to the service port of the packed valve at gas side.
3. Turn on the Air Conditioner system in cooling operation more than 10 minutes.
4. Check the operating pressure of the system should be normal value. (Ref. with product specification)
5. Release the valve rod cap of both service valves.
6. Use the Hexagon wrench to turning the valve rod of Liquid side fully close. (\*Make sure no entering air into the system)
7. Continue operate Air Conditioner system until the gauge of manifold dropped into the range of 0.5 - 0 kgf/cm<sup>2</sup>.
8. Use the Hexagon wrench to turning the valve rod of Gas side fully close. And turn off the Air Conditioner system immediately thereafter.
9. Remove the gauge manifold from the service port of the packed valve.
10. Securely tighten the valve rod cap to the both service valves.

#### CAUTION

Should be check the compressor operating condition while pumping down process. It must not any abnormal sound, more vibration. It is abnormal condition appears and must turn off the Air Conditioner immediately.

### How to open the valve

Fully open the valves of the outdoor unit. (First fully open the valve on the liquid side, and then fully open the valve on the gas side.)

\* Do not open or close the valves when the ambient temperature is -20°C or less. Doing so may damage the valve O-rings and result in refrigerant leakage.

#### Liquid side

Open the valve with a 4 mm hexagon wrench.

#### Gas side

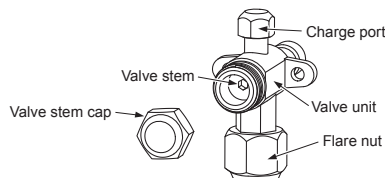

### Valve handling precautions

- Open the valve stem until it strikes the stopper. It is unnecessary to apply further force.
- Securely tighten the cap with a torque wrench.

### Cap tightening torque

Valve size	Ø12.7 mm	50 to 62 N·m (5.0 to 6.2 kgf·m)
	Ø19.1 mm	20 to 25 N·m (2.0 to 2.5 kgf·m)
Charge port		14 to 18 N·m (1.4 to 1.8 kgf·m)

### Insulating the Pipes

- The temperatures at both the liquid side and gas side will be low during cooling so in order to prevent condensation, be sure to insulate the pipes at both of these sides.
- Insulate the pipes separately for the liquid side and gas side.
- Insulate the branch pipes by following the instructions in the installation manual provided with the branch pipe kit.
- Use the insulating material provided as an accessory to insulate the Ø19.1 mm pipe at the gas side.
- Seal the area where the Ø19.1 mm pipe and Ø22.2 to Ø28.6 mm pipe are connected so that no gaps are left.

#### REQUIREMENT

Be sure to use an insulating material which can withstand temperatures above 120°C for the gas side pipe since this pipe will become very hot during heating operations.

### Replenishing refrigerant

This model is a 30 m chargeless type that does not need to have its refrigerant replenished for refrigerant pipes up to 30 m. When a refrigerant pipe longer than 30 m is used, add the specified amount of refrigerant.

#### Refrigerant replenishing procedure

1. After vacuuming the refrigerant pipe, close the valves and then charge the refrigerant while the air conditioner is not working.
2. When the refrigerant cannot be charged to the specified amount, charge the required amount of refrigerant from the charge port of the valve on the gas side during cooling.

#### Requirement for replenishing refrigerant

Replenish liquid refrigerant. When gaseous refrigerant is replenished, the refrigerant composition varies, which disables normal operation.

## Charging additional refrigerant

Figure of Single

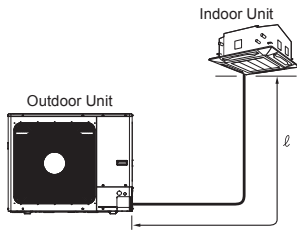

Figure of Simultaneous twin

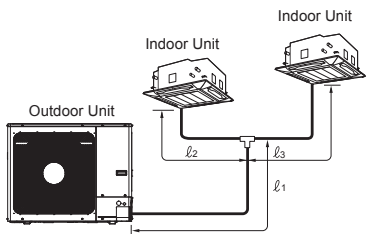

Figure of Simultaneous triple

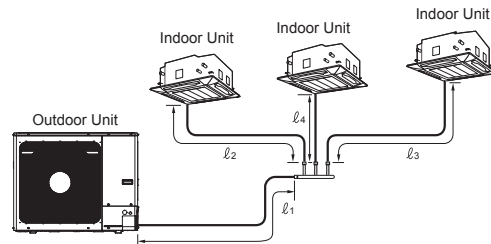
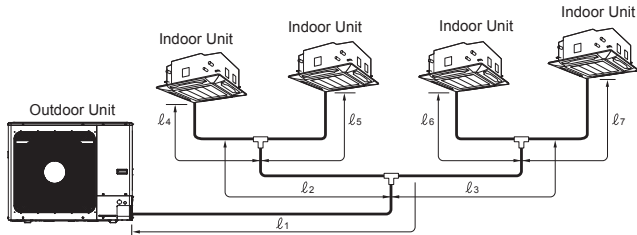

Figure of Simultaneous double twin



## Formula for calculating the amount of additional refrigerant

(Formula will differ depending on the diameter of the liquid connecting side pipe.)

\*  $l_1$  to  $l_7$  are the lengths of the pipes shown in the figures above (unit: m).

### Single

Diameter of connecting pipe (liquid side)	Amount of additional refrigerant per meter (g/m)	Amount of additional refrigerant (g) = Amount of refrigerant charged for main pipe
$l$	$\alpha$	
$\varnothing 12.7$	80	$\alpha \times (l - 30)$

### Simultaneous twin

Diameter of connecting pipe (liquid side)			Amount of additional refrigerant per meter (g/m)		Amount of additional refrigerant (g) = Amount of refrigerant charged for main pipe + amount of refrigerant charged for branch piping
$l_1$	$l_2$	$l_3$	$\alpha$	$\beta$	
$\varnothing 12.7$	$\varnothing 9.5$	$\varnothing 9.5$	80	40	$\alpha \times (l_1 - 28) + \beta \times (l_2 + l_3 - 4)$

### Simultaneous triple

Diameter of connecting pipe (liquid side)				Amount of additional refrigerant per meter (g/m)		Amount of additional refrigerant (g) = Amount of refrigerant charged for main pipe + amount of refrigerant charged for branch piping
$l_1$	$l_2$	$l_3$	$l_4$	$\alpha$	$\beta$	
$\varnothing 12.7$	$\varnothing 9.5$	$\varnothing 9.5$	$\varnothing 9.5$	80	40	$\alpha \times (l_1 - 28) + \beta \times (l_2 + l_3 + l_4 - 6)$

### Simultaneous double twin

Outdoor unit	Diameter of connecting pipe (liquid side)			Amount of additional refrigerant per meter (g/m)			Amount of additional refrigerant (g) = Amount of refrigerant charged for main pipe + amount of refrigerant charged for first branch piping + amount of refrigerant charged for second branch piping
	$l_1$	$l_2, l_3$	$l_4$ to $l_7$	$\alpha$	$\beta$	$\gamma$	
GM2243	$\varnothing 12.7$	$\varnothing 9.5$	$\varnothing 6.4$	80	40	20	$\alpha \times (l_1 - 28) + \beta \times (l_2 + l_3 - 4) + \gamma \times (l_4 + l_5 + l_6 + l_7)$
GM2803	$\varnothing 12.7$	$\varnothing 9.5$	$\varnothing 9.5$	80	40	40	

## Gas leak inspection

Use a leak detector manufactured specially for HFC refrigerant (R32, R410A, R134a, etc.) to perform the R32 gas leak inspection.

\* Leak detectors for conventional HCFC refrigerant (R22, etc.) cannot be used, as the sensitivity drops to approximately 1/40 when used for HFC refrigerant.

• R32 has a high working pressure, so failure to perform the installation work properly may result in gas leaks such as when the pressure rises during operation. Be sure to perform leak tests on the piping connections.

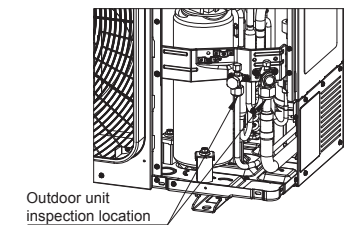
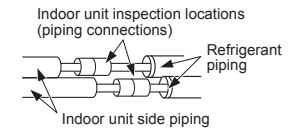

## ■ To Fix the Fluorinated Greenhouse Gases Label

This product contains fluorinated greenhouse gases. Do not vent gases into the atmosphere.

Contains fluorinated greenhouse gases	
• Chemical Name of Gas	R32
• Global Warming Potential (GWP) of Gas	675

### ⚠ CAUTION

1. Stick the enclosed refrigerant label adjacent to the service ports for charging or recovering location and where possible adjacent to existing nameplates or product information label.
2. Clearly write the charged refrigerant quantity on the refrigerant label using indelible ink. Then, place the included transparent protective sheet over the label to prevent the writing from rubbing off.
3. Prevent emission of the contained fluorinated greenhouse gas. Ensure that the fluorinated greenhouse gas is never vented to the atmosphere during installation, service or disposal. When any leakage of the contained fluorinated greenhouse gas is detected, the leak shall be stopped and repaired as soon as possible.
4. Only qualified service personnel are allowed to access and service this product.
5. Any handling of the fluorinated greenhouse gas in this product, such as when moving the product or recharging the gas, shall comply under (EU) Regulation No.517/2014 on certain fluorinated greenhouse gases and any relevant local legislation.
6. Periodical inspections for refrigerant leaks may be required depending on European or local legislation.
7. Contact dealers, installers, etc., for any questions.

Fill in the label as follows:

**Refrigerant Label**

Contains fluorinated greenhouse gases.

① Pre-charged refrigerant at factory [kg], specified in the nameplate.

② Additional charge on installation site [kg].

③ Total quantity of refrigerant in tonnes CO<sub>2</sub> equivalent.

Caution: Write out charge amount ①, ②, ①+② and ③ by indelible means on installation site.

---

**R32**    GWP:675

① =  kg      ← Pre-charged refrigerant at factory [kg], specified in the nameplate

② =  kg      ← Additional charge on installation site [kg]

---

①+② =  kg

③ =  t      ←  $\frac{\text{GWP} \times \text{kg}}{1000}$

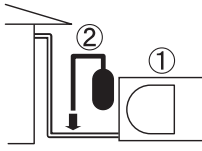

## 6 Electrical work

### ⚠ WARNING

- 1 **Using the specified wires, ensure that the wires are connected, and fix wires securely so that the external tension to the wires does not affect the connecting part of the terminals.** Incomplete connection or fixation may cause a fire, etc.
- 2 **Be sure to connect the earth wire. (Grounding work)** Incomplete earthing may lead to electric shock. Do not connect earth wires to gas pipes, water pipes, lightning rods or earth wires for telephone wires.
- 3 **The appliance shall be installed in accordance with national wiring regulations.** Capacity shortages of the power circuit or an incomplete installation may cause an electric shock or fire.

### ⚠ CAUTION

- An installation fuse must be used for the power supply line of this air conditioner.
- Incorrect / incomplete wiring may lead to an electrical fire or smoke.
- Prepare an exclusive power supply for the air conditioner.
- This product can be connected to the mains power. Fixed wire connections: A switch that disconnects all poles and has a contact separation of at least 3 mm must be incorporated in the fixed wiring.
- Be sure to use the cord clamps attached to the product.
- Do not damage or scratch the conductive core or inner insulator of the power and indoor/outdoor connecting wires when peeling them.
- Use the power and indoor/outdoor connecting wires with specified thicknesses, specified types and protective devices required.

- Remove the service panel, and the terminal cover.
- A conduit pipe can be installed through the hole for wiring. If the hole size does not fit the wiring pipe to be used, drill the hole again to an appropriate size.
- Be sure to clamp the power wires and indoor/outdoor connecting wires with a cord clamp along the connecting pipe so that the wires do not touch the compressor or discharge pipe. (The compressor and the discharge pipe become hot.)

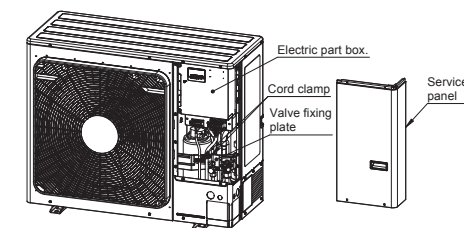

## ■ Wiring between indoor unit and outdoor unit

The dashed lines show on-site wiring.

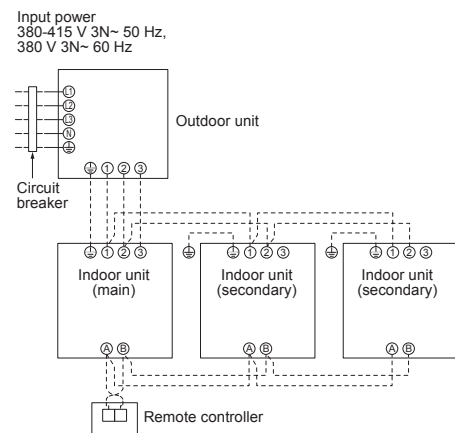

- \* (Recommendation Earth leakage circuit breaker)
- Connect the indoor/outdoor connecting wires to the identical terminal numbers on the terminal block of each unit. Incorrect connection may cause a failure.

For the air conditioner, connect a power wire with the following specifications.

## ■ Power and Wiring Specifications

Model (RAV-)	GM2243 type	GM2803 type
<b>Power supply</b>	380-415 V 3N ~ 50 Hz, 380 V 3N ~ 60 Hz	
<b>Maximum running current</b>	16 A	17 A
<b>Installation fuse rating</b>	25 A	25 A
<b>Power wire*</b>	5 × 2.5 mm <sup>2</sup> or more (H07 RN-F or 60245 IEC 66)	
<b>Indoor/outdoor connecting wires*</b>	4 × 1.5 mm <sup>2</sup> or more (H07 RN-F or 60245 IEC 66)	

\* Number of wire × wire size

## How to wire

1. Connect the indoor/outdoor connecting wires to the terminal as identified with their respective numbers on the terminal block of the indoor and outdoor units. H07 RN-F or 60245 IEC 66 (1.5 mm<sup>2</sup> or more)
2. When connecting the connecting wire to the outdoor unit terminal, prevent water from coming into the outdoor unit.
3. Secure the power supply wire and indoor/outdoor connecting wires using the cord clamp of the outdoor unit.
4. For interconnecting wires, do not use a wire joined to another on the way. Use wires long enough to cover the entire length.
5. **Wiring connections differ in conformance to EMC standards, depending whether the system is twin, triple or double twin. Connect wires according to respective instructions.**

## ⚠ CAUTION

- Fuse must be used in installation for the power supply line of this air conditioner.
- Incorrect/incomplete wiring may lead to an electrical fire or smoke.
- Prepare an exclusive power supply for the air conditioner.
- This product can be connected to the mains power. Fixed wire connections: A switch that disconnects all poles and has a contact separation of at least 3 mm must be incorporated in the fixed wiring.

## Wiring diagram

\* For details on the remote controller wiring/ installation, refer to the Installation Manual enclosed with the remote controller.

### Single system

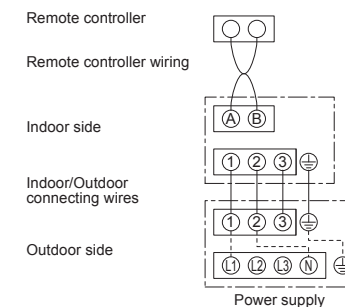

### Simultaneous twin system

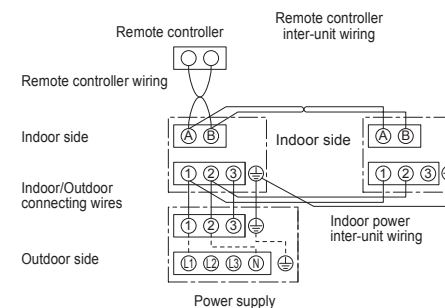

### Simultaneous triple and double twin system

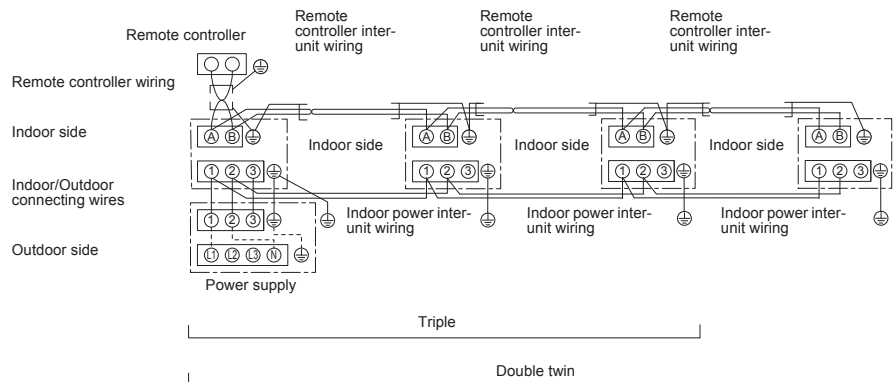

- \* Use 2-core shield wire (MVVS 0.5 to 2.0 mm<sup>2</sup> or more) for the remote controller wiring in the simultaneous twin, simultaneous triple and simultaneous double twin systems to prevent noise problems. Be sure to connect both ends of the shield wire to earth leads.
- \* Connect earth wires for each indoor unit in the simultaneous twin, simultaneous triple and simultaneous double twin systems.

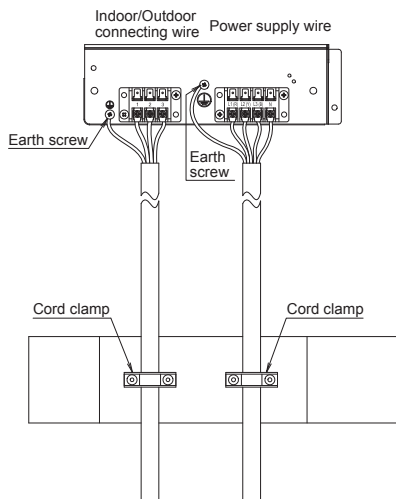

### Stripping length power cord and connecting wire

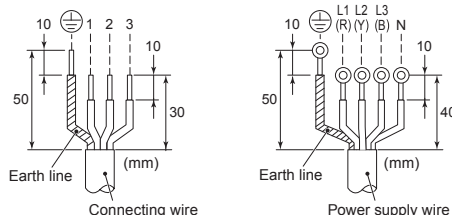

## 7 Earthing

### ⚠ WARNING

**Be sure to connect the earth wire. (Grounding work)**  
Incomplete earthing may cause an electric shock.

Connect the earth wire properly following applicable technical standards. Connecting the earth wire is essential to preventing electric shock and to reducing noise and electrical charges on the outdoor unit surface due to the high-frequency wave generated by the frequency converter (inverter) in the outdoor unit. If you touch the charged outdoor unit without an earth wire, you may experience an electric shock.

## 8 Finishing

After the refrigerant pipe, inter-unit wires, and drain pipe have been connected, cover them with finishing tape and clamp them to the wall with off-the-shelf support brackets or their equivalent. Keep the power wires and system interconnection wires off the valve on the gas side or pipes that have no heat insulator.

## 9 Test run

- **Turn on the circuit breaker at least 12 hours before starting a test run to protect the compressor during startup.**  
To protect the compressor, power is supplied from the 380-415 VAC input to the unit to preheat the compressor.
  - **Check the following before starting a test run:**
    - **That all pipes are connected securely without leaks.**
    - **That the valve of gas and liquid side are full open.**
- If the compressor is operated with the valve closed, the outdoor unit will become overpressurized, which may damage the compressor or other components. If there is a leak at a connection, air can be sucked in and the internal pressure further increases, which may cause a burst or injury.
- Operate the air conditioner in the correct procedure as specified in the Owner's Manual.

## 10 Annual maintenance

For an air conditioning system that is operated on a regular basis, cleaning and maintenance of the indoor / outdoor units are strongly recommended.

As a general rule, if an indoor unit is operated for about 8 hours daily, the indoor / outdoor units will need to be cleaned at least once every 3 months. This cleaning and maintenance should be carried out by a qualified service person.

Failure to clean the indoor / outdoor units regularly will result in poor performance, icing, water leaking and even compressor failure.



# 11 Air conditioner operating conditions

For proper performance, operate the air conditioner under the following temperature conditions:

Cooling operation	Dry bulb temp.	-15 °C to 46 °C
Heating operation	Wet bulb temp.	-27 °C to 15 °C

If air conditioner is used outside of the above conditions, safety protection may work.

# 12 Functions to be implemented locally

## ■ Handling existing pipe (Refer to 14 Appendix)

When using the existing pipe, carefully check for the following:

- Wall thickness (within the specified range)
- Scratches and dents
- Water, oil, dirt, or dust in the pipe
- Flare looseness and leakage from welds
- Deterioration of copper pipe and heat insulator

### Cautions for using existing pipe

- Do not reuse a flare nut to prevent gas leaks. Replace it with the supplied flare nut and then process it to a flare.
- Blow nitrogen gas or use an appropriate means to keep the inside of the pipe clean. If discolored oil or much residue is discharged, wash the pipe.
- Check welds, if any, on the pipe for gas leaks.

When the pipe corresponds to any of the following, do not use it. Install a new pipe instead.

- The pipe has been opened (disconnected from indoor unit or outdoor unit) for a long period.
- The pipe has been connected to an outdoor unit that does not use refrigerant R22, R410A or R407C.
- The existing pipe must have a wall thickness equal to or larger than the following thicknesses.

Reference outside diameter (mm)	Wall thickness (mm)	Material
6.4	0.8	—
9.5	0.8	—
12.7	0.8	—
15.9	1.0	—
19.1	1.2	—
22.2	1.0	Half hard
28.6	1.0	Half hard

- Do not use any pipe with a wall thickness less than these thicknesses due to insufficient pressure capacity.

## ■ Refrigerant recovery

When recovering the refrigerant in situations such as when relocating an indoor unit or outdoor unit, the recovery operation can be performed by operating the SW01 and SW02 switches on the P.C. Board of the outdoor unit. A cover for the electric parts has been installed in order to provide protection from electric shocks while work is being performed. Operate the service switches and check the LED displays with this electric parts cover in place. Do not remove this cover while the power is still on.

### ⚠ DANGER

The entire P.C. Board of this air conditioner system is a high-voltage area. When operating the service switches with the power of the system left on, wear electrically insulated gloves.

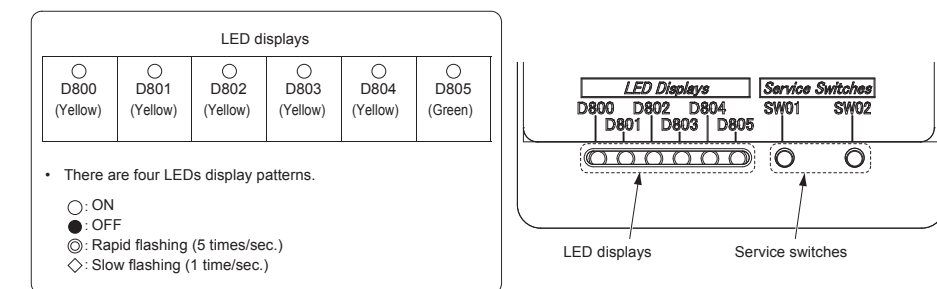

- In the initial LED display status, D805 is lighted as shown on the right. If the initial status is not established (if D805 is flashing), hold down the SW01 and SW02 service switches simultaneously for at least 5 seconds to return the LED displays to the initial status.

LED display initial status

D800 (Yellow)	D801 (Yellow)	D802 (Yellow)	D803 (Yellow)	D804 (Yellow)	D805 (Green)
● or ⊙	● or ⊙	● or ⊙	● or ⊙	● or ⊙	○
OFF or Rapid flashing	OFF or Rapid flashing	OFF or Rapid flashing	OFF or Rapid flashing	OFF or Rapid flashing	ON

- \* In order to reduce standby power, the LED indication may be turned off even when the power is on. When either SW01 or SW02 is pressed, the LED is displayed.

### Steps taken to recover the refrigerant

1. Operate the indoor unit in the fan mode.
2. Check that the LED displays are placed in their initial status. If not, place them in the initial status.
3. Hold down SW01 for at least 5 seconds, and check that D804 flashes slowly. (Fig. 1)
4. Press SW01 once to set the LED displays (D800 to D805) to the "refrigerant recovery LED display" shown below. (Fig. 2)

(Fig. 1)

LED displays indicated when step 3 is taken					
D800	D801	D802	D803	D804	D805
○	●	●	●	◇	●

○:ON, ●:OFF, ◇:Slow flashing

(Fig. 2)

Refrigerant recovery LED display					
D800	D801	D802	D803	D804	D805
○	●	●	●	◎	●

○:ON, ●:OFF, ◎:Rapid flashing

5. Press SW02 to set D805 to rapid flashing. (Each time SW02 is pressed, D805 is switched between rapid flashing and OFF.) (Fig. 3)
6. Hold down SW02 for at least 5 seconds, and when D804 flashes slowly and D805 lights, the forced cooling operation is started. (Max. 10 minutes) (Fig. 4)

(Fig. 3)

LED displays indicated when step 5 is taken					
D800	D801	D802	D803	D804	D805
○	●	●	●	◎	◎

○:ON, ●:OFF, ◎:Rapid flashing

(Fig. 4)

LED displays indicated when step 6 is taken					
D800	D801	D802	D803	D804	D805
○	●	●	●	◇	○

○:ON, ●:OFF, ◇:Slow flashing

7. After operating the system for at least 3 minutes, close the valve on the liquid side.
  8. After the refrigerant has been recovered, close the valve on the gas side.
  9. Hold down SW01 and SW02 simultaneously for at least 5 seconds. The LED displays are returned to the initial status, and the cooling operation and indoor fan operation stop.
  10. Turn off the power.
- \* If there is any reason to doubt whether the recovery was successful in the course of this operation, hold down SW01 and SW02 simultaneously for at least 5 seconds to return to the initial status, and then repeat the steps for recovering the refrigerant.

### Existing piping

#### Steps taken to support existing piping

1. Set the circuit breaker to the ON position to turn on the power.
2. Check that the LED displays are placed in their initial status. If not, place them in the initial status.
3. Hold down SW01 for at least 5 seconds, and check that D804 flashes slowly. (Fig. 5)
4. Press SW01 four times to set the LED displays (D800 to D805) to the "LED displays for existing piping settings" shown below. (Fig. 6)

(Fig. 5)

LED displays indicated when step 3 is taken					
D800	D801	D802	D803	D804	D805
○	●	●	●	◇	●

○:ON, ●:OFF, ◇:Slow flashing

(Fig. 6)

LED displays for existing piping settings					
D800	D801	D802	D803	D804	D805
●	●	○	●	◎	●

○:ON, ●:OFF, ◎:Rapid flashing

5. Press SW02 to set D805 to rapid flashing. (Each time SW02 is pressed, D805 is switched between rapid flashing and OFF.) (Fig. 7)
6. Hold down SW02 for at least 5 seconds, and check that D804 flashes slowly and that D805 lights. (Fig. 8)

(Fig. 7)

LED displays indicated when step 5 is taken					
D800	D801	D802	D803	D804	D805
●	●	○	●	◎	◎

○:ON, ●:OFF, ◎:Rapid flashing

(Fig. 8)

LED displays indicated when step 6 is taken					
D800	D801	D802	D803	D804	D805
●	●	○	●	◇	○

○:ON, ●:OFF, ◇:Slow flashing

7. Hold down SW01 and SW02 simultaneously for at least 5 seconds to return the LED displays to the initial status. The existing piping is now supported by taking the above steps. In this status, the heating capacity may decrease during heating depending on the outside air temperature and indoor temperature.
- \* If there is any reason to doubt whether establishing support was successful in the course of this operation, hold down SW01 and SW02 simultaneously for at least 5 seconds to return to the initial status, and then repeat the setting steps.

### How to check the existing piping settings

You can check whether the existing piping settings are enabled.

1. Check that the LED displays are placed in their initial status. If not, place them in the initial status.
2. Hold down SW01 for at least 5 seconds, and check that D804 flashes slowly. (Fig. 9)
3. Press SW01 four times to set the LED displays (D800 to D805) to the "LED displays for existing piping settings" shown below. If the setting is enabled, D802 lights and D804 and D805 flash rapidly. (Fig. 10)
4. Hold down SW01 and SW02 simultaneously for at least 5 seconds to return the LED displays to the initial status.

(Fig. 9)

LED displays indicated when step 3 is taken					
D800	D801	D802	D803	D804	D805
○	●	●	●	◇	●

○:ON, ●:OFF, ◇:Slow flashing

(Fig. 10)

LED displays for existing piping settings					
D800	D801	D802	D803	D804	D805
●	●	○	●	◎	◎

○:ON, ●:OFF, ◎:Rapid flashing

### When restoring the factory defaults

To restore the factory defaults in situations such as when relocating the units, follow the steps below.

1. Check that the LED displays are placed in their initial status. If not, place them in the initial status.
2. Hold down SW01 for at least 5 seconds, and check that D804 flashes slowly. (Fig. 11)
3. Press SW01 20 times to set the LED displays (D800 to D805) to the "LED displays restored to factory defaults" shown below. (Fig. 12)

(Fig. 11)

LED displays indicated when step 2 is taken					
D800	D801	D802	D803	D804	D805
○	●	●	●	◇	●

○:ON, ●:OFF, ◇:Slow flashing

(Fig. 12)

LED displays restored to factory defaults					
D800	D801	D802	D803	D804	D805
●	●	●	●	◎	●

○:ON, ●:OFF, ◎:Rapid flashing

4. Hold down SW02 for at least 5 seconds, and check that D804 flashes slowly. (Fig. 13)
5. Hold down SW01 and SW02 simultaneously for at least 5 seconds to return the LED displays to the initial status.

(Fig. 13)

LED displays indicated when step 4 is taken					
D800	D801	D802	D803	D804	D805
●	●	●	●	◇	●

○:ON, ●:OFF, ◇:Slow flashing

# 13 Troubleshooting

You can perform fault diagnosis of the outdoor unit with the LEDs on the P.C. Board of the outdoor unit in addition to using the check codes displayed on the wired remote controller of the indoor unit.

Use the LEDs and check codes for various checks. Details of the check codes displayed on the wired remote controller of the indoor unit are described in the Installation Manual of the indoor unit.

## LED displays and check codes

No.	Error	Display					
		D800	D801	D802	D803	D804	D805
1	Normal	●	●	●	●	●	○
2	Discharge temperature sensor (TD) error	◎	●	●	●	●	○
3	Heat exchanger temperature sensor (TE) error	◎	◎	●	●	●	○
4	Heat exchanger temperature sensor (TL) error	◎	◎	●	●	●	○
5	Outside temperature sensor (TO) error	●	●	◎	●	●	○
6	Suction temperature sensor (TS) error	◎	●	◎	●	●	○
7	Heatsink temperature sensor (TH) error	●	◎	◎	●	●	○
8	Miss-mounting of sensor (TE, TS)	◎	◎	◎	●	●	○
9	EEPROM error	◎	◎	●	◎	●	○
10	Compressor breakdown	◎	◎	●	◎	●	○
11	Compressor lock	●	●	◎	◎	●	○
12	Current detection circuit error	◎	●	◎	◎	●	○
13	Case thermostat activated	◎	◎	◎	◎	●	○
14	Unset model type	●	●	●	●	◎	○
15	Communication error between MCUs	◎	●	●	●	◎	○
16	Discharge temperature sensor error	●	◎	●	●	◎	○
17	High pressure SW error	◎	◎	●	●	◎	○
18	Power supply voltage error	●	●	◎	●	◎	○
19	Heatsink overheating error	●	◎	◎	●	◎	○
20	Gas leak detected	◎	◎	◎	●	◎	○
21	4-way valve reversal error	●	●	●	◎	◎	○
22	High pressure protective activated	◎	●	●	◎	◎	○
23	Fan system error	●	◎	●	◎	◎	○
24	Compressor driver device short circuit	◎	◎	●	◎	◎	○
25	Position detection circuit error	●	●	◎	◎	◎	○

○ : ON, ● : OFF, ◎ : Rapid flashing (5 times/sec.)

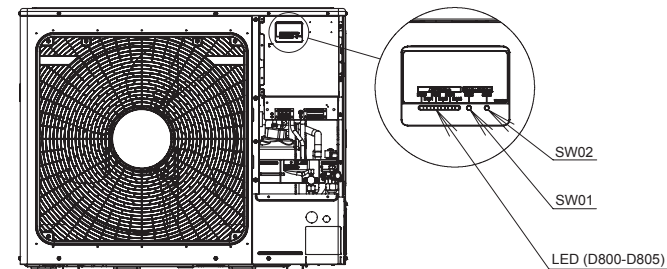

# 14 Appendix

## [1] Existing piping

### Work instructions

The existing R22 and R407C piping can be reused for our digital inverter R32 product installations.

### WARNING

**Confirming the existence of scratches or dents on the existing pipes and confirming the reliability of the pipe strength are conventionally referred to the local site.**

**If the specified conditions can be cleared, it is possible to update existing R22 and R407C pipes to those for R32 models.**

### Basic conditions needed to reuse existing pipes

Check and observe the presence of three conditions in the refrigerant piping works.

1. **Dry** (There is no moisture inside of the pipes.)
2. **Clean** (There is no dust inside of the pipes.)
3. **Tight** (There are no refrigerant leaks.)

### Restrictions for use of existing pipes

**In the following cases, the existing pipes should not be reused as they are. Clean the existing pipes or exchange them with new pipes.**

1. When a scratch or dent is heavy, be sure to use new pipes for the refrigerant piping works.
2. When the existing pipe thickness is thinner than the specified "Pipe diameter and thickness," be sure to use new pipes for the refrigerant piping works.
  - The operating pressure of R32 is high. If there is a scratch or dent on the pipe or a thinner pipe is used, the pressure strength may be inadequate, which may cause the pipe to break in the worst case.

#### \* Pipe diameter and thickness (mm)

Reference outside diameter (mm)	Wall thickness (mm)	Material
6.4	0.8	—
9.5	0.8	—
12.7	0.8	—
15.9	1.0	—
19.1	1.2	—
22.2	1.0	Half hard
28.6	1.0	Half hard

- In case the pipe diameter is  $\varnothing$ 12.7 mm or less and the thickness is less than 0.7 mm, be sure to use new pipes for the refrigerant piping works.

3. When the outdoor unit was left with the pipes disconnected, or the gas leaked from the pipes and the pipes were not repaired and refilled.
  - There is the possibility of rain water or air, including moisture, entering the pipe.
4. When refrigerant cannot be recovered using a refrigerant recovery unit.
  - There is the possibility that a large quantity of dirty oil or moisture remains inside the pipes.
5. When a commercially available dryer is attached to the existing pipes.
  - There is the possibility that copper green rust has been generated.
6. When the existing air conditioner is removed after refrigerant has been recovered.
 

Check if the oil is judged to be clearly different from normal oil.

  - The refrigerator oil is copper rust green in color: There is the possibility that moisture has mixed with the oil and rust has been generated inside the pipe.
  - There is discolored oil, a large quantity of residue, or a bad smell.
  - A large quantity of shiny metal dust or other wear residue can be seen in the refrigerant oil.
7. When the air conditioner has a history of the compressor failing and being replaced.
  - When discolored oil, a large quantity of residue, shiny metal dust, or other wear residue or mixture of foreign matter is observed, trouble will occur.
8. When temporary installation and removal of the air conditioner are repeated such as when leased etc.
9. If the type of refrigerator oil of the existing air conditioner is other than the following oil (Mineral oil), Suniso, Freol-S, MS (Synthetic oil), alkyl benzene (HAB, Barrel-freeze), ester series, PVE only of ether series.
  - The winding-insulation of the compressor may deteriorate.

### NOTE

The above descriptions are results have been confirmed by our company and represent our views on our air conditioners, but do not guarantee the use of the existing pipes of air conditioners that have adopted R32 or R410A in other companies.

### Branching pipe for simultaneous operation system

In the concurrent twin system, when has specified that branching pipe is to be used, it can be reused. Branching pipe model name:

RBC-TWP101E, RBC-TRP100E, RBC-DTWP101E

On the existing air conditioner for simultaneous operation system (twin, triple, double twin system), there are cases of branch pipes being used that have insufficient compressive strength.

In such case, please change the piping to a branch pipe for R32 or R410A.

### Curing of pipes

When removing and opening the indoor or outdoor unit for a long time, cure the pipes as follows:

- Otherwise rust may be generated when moisture or foreign matter due to condensation enters the pipes.
- The rust cannot be removed by cleaning, and new pipes are necessary.

Placement location	Term	Curing manner
Outdoors	1 month or more	Pinching
	Less than 1 month	Pinching or taping
Indoors	Every time	

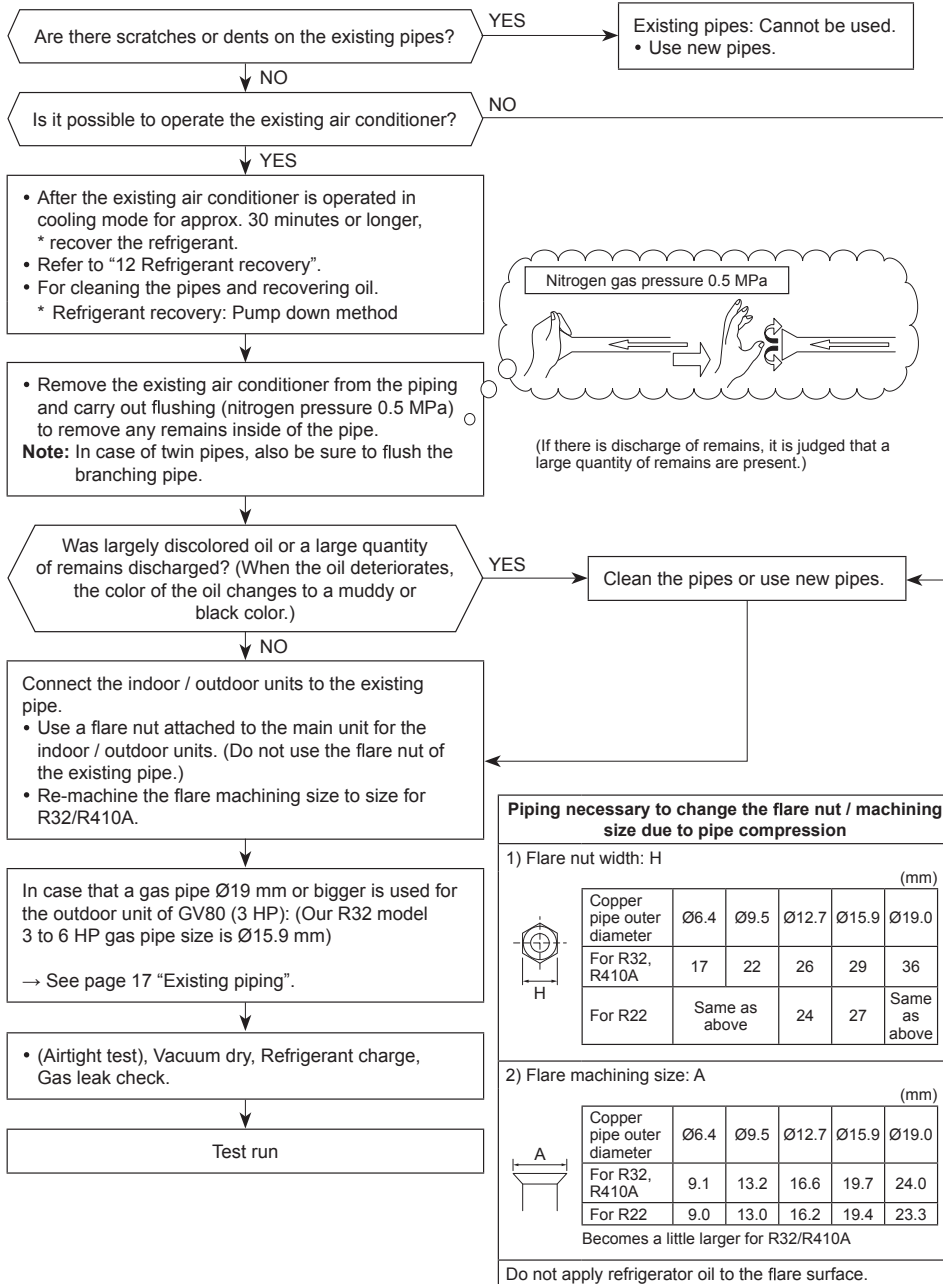

## [2] Minimum floor area: $A_{\min}$ (m<sup>2</sup>)

Piping length (m)	Total refrigerant quantity*	Floor standing unit	Wall mounted unit	Ceiling mounted unit
	$h_0$	0.6	1.8	2.2
	M (kg)	$A_{\min}$ (m <sup>2</sup> )		
~ 30	5	214.51	23.83	15.96
31	5.08	221.43	24.60	16.47
32	5.16	228.46	25.38	16.99
33	5.24	235.60	26.18	17.52
34	5.32	242.85	26.98	18.06
35	5.4	250.21	27.80	18.61
36	5.48	257.68	28.63	19.17
37	5.56	265.25	29.47	19.73
38	5.64	272.94	30.33	20.30
39	5.72	280.74	31.19	20.88
40	5.8	288.65	32.07	21.47
41	5.88	296.67	32.96	22.07
42	5.96	304.79	33.87	22.67
43	6.04	313.03	34.78	23.28
44	6.12	321.38	35.71	23.90
45	6.2	329.84	36.65	24.53
46	6.28	338.40	37.60	25.17
47	6.36	347.08	38.56	25.82
48	6.44	355.87	39.54	26.47
49	6.52	364.76	40.53	27.13
50	6.6	373.77	41.53	27.80
51	6.68	382.88	42.54	28.48
52	6.76	392.11	43.57	29.17
53	6.84	401.45	44.61	29.86
54	6.92	410.89	45.65	30.56
55	7	420.45	46.72	31.27
56	7.08	430.11	47.79	31.99
57	7.16	439.89	48.88	32.72
58	7.24	449.77	49.97	33.45
59	7.32	459.77	51.09	34.20
60	7.4	469.87	52.21	34.95

8HP  
10HP

\* Total refrigerant quantity: Refrigerant quantity precharged at factory + Additional refrigerant quantity charged during installation

# 15 Specifications

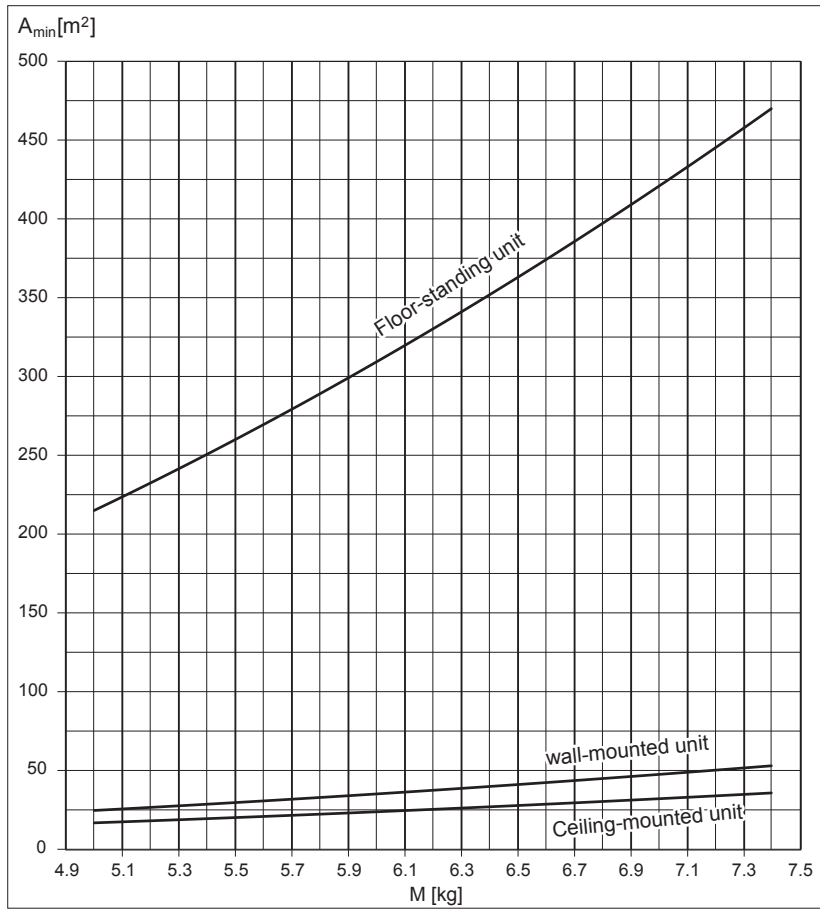

Model	Sound pressure level (dB(A))		Weight (kg)
	Cooling	Heating	
RAV-GM2243AT8P-E	58	60	117
RAV-GM2243AT8JP-E	58	60	117
RAV-GM2803AT8P-E	61	63	117
RAV-GM2803AT8JP-E	61	63	117

**Product information of ecodesign requirements. (Regulation (EU) 2016/2281)**

<http://ecodesign.toshiba-airconditioning.eu/en>

---

## Declaration of conformity

Manufacturer: CARRIER AIR CONDITIONING (THAILAND) CO., LTD.  
144/9 MOO 5, BANGKADI INDUSTRIAL PARK, TIVANON ROAD, TAMBOL BANGKADI,  
AMPHUR MUANGPATHUMTHANI, PATHUMTHANI 12000, THAILAND

TCF holder: Carrier RLC Europe S.A.S  
Immeuble Le Cristalia 3 rue Joseph Monier  
92500 Rueil-Malmaison FRANCE

Hereby declares that the machinery described below:

Generic Denomination: Air Conditioner

Model / type: RAV-GM2243AT8P-E, RAV-GM2243AT8JP-E  
RAV-GM2803AT8P-E, RAV-GM2803AT8JP-E

Commercial name: Digital Inverter Series Air Conditioner

Complies with the provisions of the Machinery Directive (Directive 2006/42/EC) and the regulations transposing into national law

Name: Kazunari Watanabe  
Position: GM, Quality Assurance Dept.  
Date: 18 Nov, 2024  
Place Issued: Thailand

### NOTE

This declaration becomes invalid if technical or operational modifications are introduced without the manufacturer's consent.

---

---

## Declaration of conformity

Manufacturer: CARRIER AIR CONDITIONING (THAILAND) CO., LTD.  
144/9 MOO 5, BANGKADI INDUSTRIAL PARK, TIVANON ROAD, TAMBOL BANGKADI,  
AMPHUR MUANGPATHUMTHANI, PATHUMTHANI 12000, THAILAND

TCF holder: Carrier Solutions UK Ltd.  
Porsham Close, Belliver Industrial Estate,  
PLYMOUTH, Devon,  
PL6 7DB, United Kingdom

Hereby declares that the machinery described below:

Generic Denomination: Air Conditioner

Model / type: RAV-GM2243AT8P-E, RAV-GM2243AT8JP-E  
RAV-GM2803AT8P-E, RAV-GM2803AT8JP-E

Commercial name: Digital Inverter Series Air Conditioner

Complies with the provisions of the Supply of Machinery (Safety) Regulations 2008

Name: Kazunari Watanabe  
Position: GM, Quality Assurance Dept.  
Date: 18 Nov, 2024  
Place Issued: Thailand

### NOTE

This declaration becomes invalid if technical or operational modifications are introduced without the manufacturer's consent.

---

## Warnings on refrigerant leakage

### Check of concentration limit

**The room in which the air conditioner is to be installed requires a design that in the event of refrigerant gas leaking out, its concentration will not exceed a set limit.**

The refrigerant R32 which is used in the air conditioner is safe, without the toxicity or combustibility of ammonia, and is not restricted by laws to be imposed which protect the ozone layer. However, since it contains more than air, it poses the risk of suffocation if its concentration should rise excessively. Suffocation from leakage of R32 is almost non-existent.

If a conditioner system is to be installed in a small room, select a suitable model and installation procedure so that if the refrigerant accidentally leaks out, its concentration does not reach the limit (and in the event of an emergency, measures can be made before injury can occur).

In a room where the concentration may exceed the limit, create an opening with adjacent rooms, or install mechanical ventilation combined with a gas leak detection device.

The concentration is as given below.

$$\frac{\text{Total amount of refrigerant (kg)}}{\text{Min. volume of the indoor unit installed room (m}^3\text{)}} \leq \text{Concentration limit (kg/m}^3\text{)}$$

Refrigerant Concentration Limit shall be in accordance with local regulations.



# 16 Installation check list

After finishing installation work, please check items below and hand this sheet to user to keep it in a safe place together with Owner and Installation Manuals

Model name \_\_\_\_\_

Check date \_\_\_\_\_

Checked by \_\_\_\_\_

**Note : Please put a mark “ ✓ ” in the box you checked.**

## ■ Piping work

Check items	Symptom	Check
Connecting pipes are cleaned and no dent		
Use vacuum pump for completed vacuuming	Insufficient Air conditioner capacity Compressor malfunction Compressor rupture or Burst	
No any gas leakage or clogging is found		
Service valves are fully open before operation		

## ■ Wiring work

Check items	Symptom	Check
Electrical wires are connected correctly	Burnt out, No operation	
Use breaker to connect to main power supply	Burnt out, No abnormal protection	
Wiring insulators are in good condition	Burnt out, Electrical leakage	
Use the specified size/rating wires	Burnt out	
Ground wire must be installation per manufacturing Installation Manual	Electrical leakage or shock	

## ■ Drainage work

Check items	Symptom	Check
Drain hose is properly connected	Water leakage or dripping	
Drain hose is well insulated	Water or dew droppng	

**Remark : All check items, please refer procedure from manufacturing Installation Manual**

# **CARRIER AIR CONDITIONING (THAILAND) CO., LTD.**

144/9 MOO 5, BANGKADI INDUSTRIAL PARK, TIVANON ROAD, TAMBOL BANGKADI, AMPHUR MUANGPATHUMTHANI, PATHUMTHANI 12000, THAILAND

1135601001A